



SR 174/SR 20 Intersection Analysis

Nevada County
Transportation
Commission





This page intentionally left blank.



Table of Contents

Table Index.....	ii
1. Introduction.....	1
1.1 Setting.....	2
1.2 Previous Planning Efforts	4
1.3 Community Engagement	6
2. Existing Conditions.....	6
2.1 Study Area Roadways	6
2.2 Existing Traffic Operations.....	7
2.3 Collision Analysis and Safety Summary	10
3. Forecasts.....	11
4. Improvement Alternatives	13
4.1 Alternative 1	13
4.2 Alternative 2	13
4.3 Alternative 3.....	13
4.4 Alternative 4	13
4.5 Comparison of Alternatives 1-4	14
4.6 Alternative 5.....	14
5. Recommended Improvements	14
5.1 Future Traffic Operations	15



Figure Index

Figure 1.1: Study Area Map	1
----------------------------------	---

Table Index

Table 1.1 Commuter Travel Time to Work	3
Table 1.2 Means of Commuter Transportation to Work	3
Table 2.1 Level of Service Criteria for Intersections	8
Table 2.2 Existing Conditions Intersection Operations	9
Table 2.3 Roadway Collision Analysis	11
Table 2.4 Intersection Collision Analysis.....	11
Table 3.1 Travel Demand Model Volume Comparison for AM Peak Hour	12
Table 3.2 Travel Demand Model Volume Comparison for PM Peak Hour	12
Table 4.1 Comparison of Alternatives 1-4.....	14
Table 5.1 Cumulative Conditions with No Project.....	15
Table 5.2 Cumulative Conditions with Project.....	16

Appendix Index

Appendix A Traffic Operations Data
Appendix B Roundabout Concept and Design Checks



1. Introduction

The Nevada County Transportation Commission (NCTC) retained GHD to analyze and recommend improvements for the intersection of State Route (SR) 174 and SR 20 in Grass Valley, the largest city in western Nevada County. Located 34 miles east of Yuba City and 57 miles north of Sacramento, Grass Valley lies in the western foothills of the Sierra Nevada mountain range. SR 174, SR 20, and SR 49 connect the city to Nevada County and beyond.

The study area includes several local streets that intersect with or pass under the two state routes at this location, known as “the Triangle” due to the shape formed by these streets. SR 20 runs from southwest to northeast at this location. South Auburn Street and Neal Street intersect northwest of SR 20, forming two sides of the Triangle. Tinloy Street and Hansen Way are two-lane, one-way collectors between the on-ramps and off-ramps for Route 20 in the study area. Neal Street is designated as SR 174/Colfax Avenue east of Tinloy Street. A map of the study area is shown in Figure 1.1, with state facilities highlighted in yellow.

Figure 1.1: Study Area Map



There are seven intersections within this complex study area, including two offset intersections where cross streets are not aligned:



1. South Auburn Street & Eastbound Off-Ramp/Hansen Way (offset)
2. South Auburn Street & Westbound On-Ramp/Tinloy Street
3. South Auburn Street & Neal Street
4. Tinloy Street & Colfax Avenue
5. Hansen Way & Colfax Avenue/SR 174 (offset)
6. Hansen Way & Bank Street
7. Tinloy Street & Bank Street

In addition to providing local access to schools, transit, businesses, and jobs, these routes serve regional connectivity to destinations in Nevada County and beyond. The study area currently experiences congestion with respect to queues spilling back into the adjacent intersections during peak travel times, which is expected to worsen as the community grows and traffic volumes increase over the next 20 years. With many intersections located close together, congestion at one intersection can quickly lead to congestion at others. Bicycle and pedestrian facilities in the area are incomplete, which can create challenges for people walking or bicycling. In summary, the study intersections experience the following safety and operations issues that need to be addressed:

- Safety
 - 27 collisions from the most recent 10 year data
 - 7 of which were injury accidents and four involving bicycles
- Operations
 - Complicated (sometimes confusing) layout
 - High traffic volumes lead to unnecessary delays and queue spillback

This study focuses on identifying cost effective solutions to improve traffic flow, pedestrian and bicycle access, safety, and aesthetics.

1.1 Setting

1.1.1 Transportation

Table 1.1 presents commuter travel times to work in the area based on the United States Census Bureau's American Community Survey (ACS). The mean travel time to work for Grass Valley is 14.9 minutes, which is 9.6 minutes faster than the county average of 24.5 minutes. This aligns with 85.6 percent of the working population of Grass Valley working within the county limits.



Table 1.1 Commuter Travel Time to Work

Travel Time to Work	Grass Valley		Nevada County	
	Estimate	Percentage	Estimate	Percentage
Less than 10 minutes	1,795	39.1%	8,199	20.0%
10 to 14 minutes	1,248	27.2%	7,174	17.5%
15 to 19 minutes	634	13.8%	6,887	16.8%
20 to 24 minutes	184	4.0%	5,002	12.2%
25 to 29 minutes	110	2.4%	2,009	4.9%
30 to 34 minutes	239	5.2%	3,895	9.5%
35 to 44 minutes	78	1.7%	1,640	4.0%
45 to 59 minutes	60	1.3%	2,419	5.9%
60 or more minutes	243	5.3%	3,771	9.2%
Mean Travel Time to Work	14.9 minutes		24.5 minutes	

Source: U.S. Census Bureau; Commuting Characteristics, 2013-2017 American Community Survey 5-Year Estimates

Table 1.2 shows the means of transportation to work used by commuters. The percentage of people who drive alone is 8.8 percent less than the County percentage of 74.4 percent. The percentages of people carpooling and walking are more than twice the County percentages, at 18.4 percent and 9.3 percent compared to 8.5 percent and 2.8 percent, respectively.

Table 1.2 Means of Commuter Transportation to Work

Mode of Transportation	Grass Valley		Nevada County	
	Estimate	Percentage	Estimate	Percentage
Drive Alone	3,012	65.6%	30,500	74.4%
Carpool	845	18.4%	3,485	8.5%
Public Transportation	46	1.0%	492	1.2%
Walked	427	9.3%	1,148	2.8%
Bicycle	64	1.4%	369	0.9%
Taxicab, Motorcycle, Bicycle, or Other Means	32	0.7%	738	1.8%
Worked at Home	165	3.6%	4,264	10.4%
Total	4,591		40,996	

Source: U.S. Census Bureau; Commuting Characteristics, 2013-2017 American Community Survey 5-Year Estimates

1.1.2 Demographics

The population of Grass Valley is estimated to be 12,860, about 13 percent of Nevada County's population. The total area within the city limit is 5.25 square miles.

The Median Household Income in Grass Valley is \$35,157 which is 42 percent lower than the Median Household Income for Nevada County, which is \$60,610. The Mean Household Income for Grass Valley is \$54,318, while the Mean Income for the County is \$83,686. Approximately 10



percent of the housing units were vacant as of 2017, 22 percent less than the County average. Of those occupied, 38.9 percent of the houses in Grass Valley are owner-occupied compared to the 74 percent for the County.

1.1.3 Transit

Grass Valley is served by two public transportation services: Gold County Stage and Gold LIFT.

Gold County Stage has six bus routes that stop within Grass Valley City limits. The routes can take passengers as far north as Nevada City and as far south as Auburn. The routes make many stops throughout Grass Valley and the surrounding communities. Headway times vary by routes from one to two hours, making it difficult for passenger to make connections and use transit as a reliable mode of transportation. Route 7 goes past the North San Juan area from between La Barr and Grass Valley.

1.2 Previous Planning Efforts

This study builds on previous planning efforts in the project area, carrying forward the priorities and proposed improvements from documents summarized below.

1.2.1 Wolf Creek Parkway Alignment Study and Conceptual Master Plan (2006)

This study and master plan established a potential route for a 2.2-mile bicycling and walking trail along Wolf Creek in the city of Grass Valley. In the Triangle study area, the channelized creek runs parallel to SR 20 on the northwest side. Three alternatives were presented:

Alternative 1 is the most transformative, involving a trailhead gateway plaza on the east side of the Neal Street and South Auburn Street intersection and promenade paths created along both sides of the channelized creek. The creek would be “daylit” to improve habitat value for wildlife and create a more pleasant creek-trail experience.

Alternative 2 includes paths along both sides of the creek through the Triangle area, with a small trailhead located in the Park and Ride lot.

Alternative 3 would provide bicycling facilities along Tinloy Street as a low-cost connection between other bicycle and pedestrian facilities along the creek corridor.

Alternative 1 was identified as the preferred concept by the community.

1.2.2 Street System Master Plan for the City of Grass Valley (2004)

The Street System Master Plan identifies transportation deficiencies, documents mitigation measures needed to achieve level of service (LOS) D or better, and outlines cost estimates and funding strategies for these mitigation measures.

Operational deficiencies with respect to queue spillbacks were identified at Neal Street and SR 174 from Mill Street to the frontage road, as well as on South Auburn Street from Neal Street to the SR 20 off-ramp. Traffic operations operate indicate severe congestion and long delays with intersections that exceed capacity. The study notes the three closely spaced signalized



intersections (90 feet apart) contribute to low capacity and operational challenges. Tinloy Street and Hansen Way are underutilized due to poor intersection design.

In addition, the Triangle study area presents safety challenges for all modes of transportation. The location had the highest number of reported collisions in the City, according to the Street System Master Plan.

Recommended improvements to the area included reconfiguring the multiple closely-spaced intersections to function as a single, larger intersection. In addition, the master plan cites several policies intended to improve traffic operations by promoting walking, bicycling, and transit use.

1.2.3 Nevada County Active Transportation Plan (2019)

The Nevada County Active Transportation Plan (ATP) documents existing challenges and proposes programs, policies, and infrastructure projects to improve walking and bicycling throughout the county and incorporated cities, including Grass Valley.

No existing bicycle facilities were documented in the Triangle study area. Neal Street/SR 174 and South Auburn Street have sidewalks on both sides, and Tinloy Street has sidewalk on the north side. All other streets lack sidewalks.

Some bicycle-involved collisions were reported in the study area, which did not result in either severe injury or fatality. This indicates some people are bicycling in the area despite the lack of dedicated facilities. Pedestrian-involved collisions were also reported, including one that resulted in a severe injury.

Proposed improvements in the Triangle area include bicycle lanes on SR 174, a bicycle route on South Auburn Street, and a shared use path along the Wolf Creek corridor, parallel to SR 20 on the northwest side. New bicycle parking is also recommended in the area. New sidewalk is proposed on the south side of Hansen Way along with crossing improvements at all intersections in the area.

The ATP also includes a summary of disadvantaged community criteria commonly used in competitive grant funding programs. Grass Valley is likely to meet disadvantaged community thresholds for Median Household Income.

1.2.4 Grass Valley Corridor Improvement Project (2005)

This project proposes to improve the Idaho-Maryland/East Main intersection and the substandard weave between the Idaho-Maryland on-ramp and the Bennett Street off-ramp on southbound Highway 49. Improvements would realign the eastbound approach of Neal Street at South Auburn Street to “square up” the intersection. Neal Street between South Auburn Street and Tinloy Street would be closed and incorporated into the expanded Park and Ride lot. East of Tinloy Street, SR 174 would be reduced to one lane westbound.

1.2.5 Grass Valley 2020 General Plan (1999)

Community outreach conducted during development of the 2020 General Plan identified a desire to reduce congestion, calm traffic in neighborhoods, and promote active transportation and transit.



1.3 Community Engagement

1.3.1 Public Workshop

An Open House was held on Wednesday, November 20, 2019 at Grass Valley City Hall from 4:30 to 5:30 PM. The Open House provided an opportunity to present the improvement alternatives and a three dimensional micro-simulation model to the public for feedback. A handful of stakeholders attended, including a Planning Commissioner, a business owner whose property is within the project area, and a person who bicycles for transportation purposes on a daily basis. The feedback gathered was positive; attendees were happy to see additional facilities for bicyclists and pedestrians, connections to other local facilities, and improved crossings. Attendees were also pleased that the operations appear simplified from the existing state, that use of property from adjacent landowners is small, and that the Park and Ride lot under the freeway is maintained.

2. Existing Conditions

2.1 Study Area Roadways

Roadways that provide the primary vehicle circulation within the study area are South Auburn Street, Tinloy Street, Neal Street, State Route 174, State Route 20/49, Hansen Way, and Bank Street. The following are brief descriptions of the study area roadways.

South Auburn Street is a two-lane arterial that runs north-south through the study area. It forms the north and south legs of three of the study intersections.

Tinloy Street is a local road that runs parallel to SR 20/49. The street is a two-lane, one-way street that connects the off-ramp and on-ramp along SR 20/49. Tinloy Street runs through two of the study intersections.

Neal Street is a two-lane arterial that runs east/west through the study area. Neal Street turns into SR 174 at S Auburn Street. Neal Street runs through three study intersections.

State Route 174, also known as Colfax Highway, is a two-lane arterial that runs east/west through the study area. SR 174 starts at S Auburn Street and continues east through Grass Valley. The speed limit is 25 mph through the study area. SR 174 connect commuters within Grass Valley as well as regionally to Peardale and Colfax.

State Route 20/49 is a freeway that runs over the study area. SR 20/49 has two ramps within the study area that are the east legs of two of the study intersections. The speed limit through the study area is 60 mph. SR 20 and SR 49 merge on the south end of Grass Valley and diverge on the North end of Nevada City. They connect commuters regionally to Glenbrook and Nevada City.

Hansen Way is a local road that connects the on-ramp and off-ramp of SR 20/49. The street is a two-lane, one-way street that runs parallel to SR 20/49. Hansen Way runs through two of the study intersections.

Bank Street is a local road that runs east/west through the study area. Within the study area Bank Street is a two-way, two-lane road. Bank Street runs through two of the study intersections.



2.2 Existing Traffic Operations

Seven intersections were selected for evaluation in this study:

1. South Auburn Street & Eastbound Off-Ramp/Hansen Way
2. South Auburn Street & Westbound On-Ramp/Tinloy Street
3. South Auburn Street & Neal Street
4. Tinloy Street & Colfax Avenue
5. Hansen Way & Colfax Avenue/SR 174
6. Hansen Way & Bank Street
7. Tinloy Street & Bank Street

Existing intersection operations were quantified in terms of Level of Service (LOS) for the seven study intersections utilizing existing traffic volumes collected during weekday AM and PM peak hours.

2.2.1 Level of Service Methodologies

Traffic operations are quantified through the determination of "Level of Service" (LOS). Level of service is a qualitative measure of traffic operating conditions, whereby a letter grade "A" through "F" is assigned to an intersection, representing progressively worsening traffic operations as determined by vehicle delay or congestion. Table 2.1 presents the vehicular delay-based LOS criteria for different types of intersection control. For an all-way stop-controlled (AWSC) intersection, the LOS determination is based on averaged delay for all approaches. For a two-way or one-way (T-intersection) stop-controlled (TWSC) intersection, the LOS determination is based on the worst-performing approach.



Table 2.1 Level of Service Criteria for Intersections

Level of Service	Type of Flow	Delay	Maneuverability	Stopped Delay/Vehicle		
				Signalized	Un-signalized	All-Way Stop
A	Stable Flow	Very slight delay. Progression is very favorable, with most vehicles arriving during the green phase not stopping at all.	Turning movements are easily made, and nearly all drivers find freedom of operation.	<10.0	<10.0	<10.0
B	Stable Flow	Good progression and/or short cycle lengths. More vehicles stop than for LOS A, causing higher levels of average delay.	Vehicle platoons are formed. Many drivers begin to feel somewhat restricted within groups of vehicles.	>10.0 and <20.0	>10.0 and <15.0	>10.0 and <15.0
C	Stable Flow	Higher delays resulting from fair progression and/or longer cycle lengths. Individual cycle failures may begin to appear at this level. The number of vehicles stopping is significant, although many still pass through the intersection without stopping.	Back-ups may develop behind turning vehicles. Most drivers feel somewhat restricted	>20.0 and <35.0	>15.0 and <25.0	>15.0 and <25.0
D	Approaching Unstable Flow	The influence of congestion becomes more noticeable. Longer delays may result from some combination of unfavorable progression, long cycle lengths, or high volume-to-capacity ratios. Many vehicles stop, and the proportion of vehicles not stopping declines. Individual cycle failures are noticeable.	Maneuverability is severely limited during short periods due to temporary back-ups.	>35.0 and <55.0	>25.0 and <35.0	>25.0 and <35.0
E	Unstable Flow	Generally considered to be the limit of acceptable delay. Indicative of poor progression, long cycle lengths, and high volume-to-capacity ratios. Individual cycle failures are frequent occurrences.	There are typically long queues of vehicles waiting upstream of the intersection.	>55.0 and <80.0	>35.0 and <50.0	>35.0 and <50.0
F	Forced Flow	Generally considered to be unacceptable to most drivers. Often occurs with over saturation. May also occur at high volume-to-capacity ratios. There are many individual cycle failures. Poor progression and long cycle lengths may also be major contributing factors.	Jammed conditions. Back-ups from other locations restrict or prevent movement. Volumes may vary widely, depending principally on the downstream back-up conditions.	>80.0	>50.0	>50.0

Source: Highway Capacity Manual, Sixth Edition, A Guide to Multimodal Mobility Analysis, 2016 (HCM 6)



2.2.2 Applicable Agency LOS Guidelines and Policies

Caltrans LOS Guidelines

Caltrans' Guide for the Preparation of Traffic Impact Studies contains the following policy pertaining to the LOS standards within Caltrans jurisdiction:

Caltrans endeavors to maintain a target LOS at the transition between LOS “C” and LOS “D” on State highway facilities. However, Caltrans acknowledges that this may not always be feasible and recommends that the lead agency consult with Caltrans to determine the appropriate target LOS.

Grass Valley Guidelines

The Grass Valley General Plan contains the following policy pertaining to LOS standards within the City's jurisdiction:

The City has established Level of Service “D” as the goal for both the General Plan and for the development of Citywide and regional traffic impact fees.

2.2.3 Intersection Operations

Existing weekday AM and PM peak hour intersection traffic operations were quantified utilizing the existing traffic volumes and existing intersection lane geometrics and control. Appendix A includes maps of the existing lane geometrics and controls and the existing peak hour traffic volumes for the study intersections. Table 2.2 presents the intersection operations for the Existing Conditions.

Table 2.2 Existing Conditions Intersection Operations

#	Intersection	Control Type ^{1,2}	AM Peak Hour		PM Peak Hour	
			Delay	LOS	Delay	LOS
1	Auburn Street & Hansen Way/ EB Off-Ramp	OWSC	24.5	C	21.7	C
2	Auburn Street & Tinloy Street/ WB On-Ramp	Signal	12.1	B	11.1	B
3	Auburn Street & Neal Street	Signal	9.7	A	11.4	B
4	Tinloy Street & Colfax Avenue	Signal	15.7	B	15.9	B
5	Hansen Way & Colfax Avenue/ SR 174	AWSC	14.3	B	12.4	B
6	Hansen Way & Bank Street	AWSC	8.9	A	9.3	A
7	Tinloy Street & Bank Street	AWSC	9.2	A	10.8	B

Notes:

1. AWSC = All Way Stop Control; OWSC = One Way Stop Control; RNDBT = Roundabout

2. LOS = Delay based on worst minor street approach for O/TWSC intersections, average of all approaches for AWSC, Signal

As shown in Table 2.2, all of the intersections are operating better than LOS D. The LOS work sheets for each study intersection are attached in Appendix A. Since currently none of the intersections are failing, Warrant Analysis was not completed for the intersections. Although the intersections are performing at acceptable LOS, field observations indicate that the 95% queues for



majority of the movements exceed available storage. This finding is consistent with the previous studies done for the study area.

2.3 Collision Analysis and Safety Summary

State Departments of Transportation are required to create a safety plan specific to their state's safety needs under the current transportation-funding bill (FAST Act) and the Highway Safety Improvement Plan (HSIP). A Strategic Highway Safety Plan (SHSP) is a statewide-coordinated safety plan that provides a comprehensive framework for reducing highway fatalities and serious injuries on all public roads. SHSPs are a critical and comprehensive tool for states to keep moving towards zero deaths related to motor vehicles and roadways. California's SHSP for 2015-2019 has adopted a "Toward Zero Deaths" (TZD) strategy for reducing traffic fatalities and injuries. TZD is also a national strategy supported by the Federal Highway Administration and many other organizations.

Collision data for Grass Valley, SR 20/49, and SR 174 were derived from the California Highway Patrol Statewide Integrated Traffic Records System (SWITRS) and the Transportation Injury Mapping System (TIMS) for a 12-year period between January 1, 2007 and December 31, 2018. The accuracy of the data is subject to reporting levels of the law enforcement agencies supplying the collision reports. There were 27 collisions reported in the study area. The majority of the collisions resulted in property damage only, with only two severe injury collisions and four complaint of pain injuries.

2.3.1 Collision Rates

The 12-year period from January 1, 2007 to December 31, 2018 was analyzed for roadway segments and intersections. The collision rate is calculated for each facility type to determine relative safety compared to other similar roadways, segments, or intersections. Collision rates are defined as the number of collisions per million vehicle miles traveled (COLL/MVM) for roadway segments, and the number of collisions per million vehicles entering the intersection (COLL/MVE) for intersections. The vehicle miles traveled is equal to the average daily traffic (ADT) volumes multiplied by the length of the segment, multiplied by the number of years of data, and multiplied by 365 days per year. The roadway collision rate equation is shown below:

$$\text{Collision Rate} = \frac{(\text{Number of Collisions}) \times (1,000,000)}{\text{Vehicle Miles Traveled}}$$

The calculated collision rates are compared to statewide average rates for similar facilities compiled by the California Department of Transportation (Caltrans) as published in their *2015 Collision Data on California State Highways*¹. The document provides basic average collision rates, derived from SWITRS data, for various types of roadways and intersections, categorized by highway type, control type, intersection type, design speed, area type, and terrain.

¹ California Department of Transportation [2015 Collision Data on California State Highways](#) (road miles, travel, collisions, collision rates), Division of Research, Innovation, and System Information, Sacramento, CA.



The collision rates were calculated for both roadways and intersections and compared to the statewide average for similar facilities. Table 2.3 presents the roadway analysis for the study area around the intersection of SR 20 and SR 174 and how it compares to the statewide averages.

Table 2.3 Roadway Collision Analysis

Roadway	Length (mi)	ADT ¹	MVM ²	Collisions			Grass Valley			State Average		
				Total	Fatal	Injury	Collision Rate	% Fatal	% Fatal + Injury	Collision Rate	% Fatal	% Fatal + Injury
South Auburn St	0.2	6,580	5.8	1	0	0	0.17	0	0	2.09	1.0%	40.2%
SR 174	0.2	5,550	4.9	8	0	3	1.65	0	37.5%	2.09	1.0%	40.2%
Hansen Way	0.2	3,100	2.7	2	0	0	0.74	0	0	2.09	1.0%	40.2%
Neal St	0.2	5,930	5.2	6	0	1	1.16	0	16.7%	2.09	1.0%	40.2%
Bank St	0.2	1,890	1.7	0	0	0	0	-	-	2.09	1.0%	40.2%
Tinloy St	0.2	4,140	3.6	2	0	0	0.55	0	0	2.09	1.0%	40.2%

1. Average Daily Traffic
2. Million Vehicle Miles

As presented in Table 2.3, all of the study area segments have lower collision rates than the statewide average. This is true for injury and fatality percentages as well. Table 2.4 presents the intersection collision analysis for the study area.

Table 2.4 Intersection Collision Analysis

No	Intersection	Control	Total Vehicles	Collisions			Grass Valley			State Average		
				Total	Fatal	Injury	Collision Rate	% Fatal	% Fatal + Injury	Collision Rate	% Fatal	% Fatal + Injury
1	Auburn St & EB Off-ramp/Hansen Way	Signal	76.3 M	0	0	0	0	-	-	0.24	0.004	0.292
2	Auburn St & WB On-ramp/Tinloy St	Stop	90.8 M	1	0	0	0.011	0	0	0.19	0.005	0.45
3	Auburn St & Neal St	Signal	117.3 M	0	0	0	0	-	-	0.24	0.004	0.292
4	Tinloy St & Colfax Avenue	Signal	76.1 M	7	0	2	0.092	0	0.286	0.24	0.004	0.292
5	Hansen Way & Colfax Avenue/SR 174	Stop	74.8 M	8	0	1	0.107	0	0.125	0.19	0.005	0.45
6	Hansen Way & Bank St	Stop	43.6 M	0	0	0	0	-	-	0.19	0.005	0.45
7	Tinloy St & Bank St	Stop	63.5 M	2	0	0	0.031	0	0	0.19	0.005	0.45

As presented in Table 2.4, collision rates at the intersections in the study are lower than the statewide average. The percent fatality plus injury is also lower than the state average, this due to most of the accidents within the study area being property damage only.

3. Forecasts

Future volumes for the study area were forecast using the NCTC Travel Demand Models (TDM) for Grass Valley. The base volume year used in the TDM was 2012 and the forecasted year is 2035. Table 3.1, Table 3.2 and 3.3 show how the base volumes compare to the 2035 forecasted volumes for the AM and PM peak hours for the approach legs that feed volumes to the study area.



Table 3.1 Travel Demand Model Volume Comparison for AM Peak Hour

Road	Segment	2012	2035	Difference	Percent Growth
South Auburn	North of Neal/ SR174, Southbound	112	113	1	1%
South Auburn	South of Hansen, Northbound	430	564	134	31%
SR 20/49	Southbound Off-Ramp SR 20/49	871	733	-138	-16%
SR 20/49	Southbound On-Ramp SR 20/49	492	561	69	14%
Tinloy Street	Between Bank and SR 174	292	342	50	17%
Neal Street	West of South Auburn, Eastbound	909	1020	111	12%
SR 174	East of Hansen. Westbound	607	736	129	21%
Totals		3713	4069	356	10%

Table 3.2 Travel Demand Model Volume Comparison for PM Peak Hour

Road	Segment	2012	2035	Difference	Percent Growth
South Auburn	North of Neal/ SR174, Southbound	466	532	66	14%
South Auburn	South of Hansen, Northbound	503	608	105	21%
SR 20/49	Southbound Off-Ramp SR 20/49	1022	1129	107	10%
SR 20/49	Southbound On-Ramp SR 20/49	1024	1046	22	2%
Tinloy Street	Between Bank and SR 174	670	867	197	29%
Neal Street	West of South Auburn, Eastbound	1360	1483	123	9%
SR 174	East of Hansen. Westbound	957	1106	149	16%
Totals		6002	6771	769	13%

Table 3.3 Travel Demand Model Volume Comparison for Daily Volume

Road	Segment	2012	2035	Difference	Percent Growth
South Auburn	North of Neal/ SR174, Southbound	2130	2533	403	19%
South Auburn	South of Hansen, Northbound	2603	3320	717	28%
SR 20/49	Southbound Off-Ramp SR 20/49	4646	4729	83	2%
SR 20/49	Southbound On-Ramp SR 20/49	3948	4229	281	7%
Tinloy Street	Between Bank and SR 174	2737	3498	761	28%
Neal Street	West of South Auburn, Eastbound	5378	5895	517	10%
SR 174	East of Hansen. Westbound	4144	4857	713	17%
Totals		25586	29061	3475	14%



Overall the AM volumes grew about 9 percent, PM volumes grew by about 13 percent and daily volumes grew by about 14 percent over the 23 year period.

These growth rates were compared to the percent growth between the traffic counts that were taken for this project and traffic counts taken in 2008 for another nearby study: the Idaho Maryland Mine TIS.

Over the ten year period between the Idaho Maryland counts and the recent traffic count taken for this project the AM grew about 10 percent and the PM declined, with a decline of about 4 percent.

The study area is largely built. Based on this and direction from the project development team, a cumulative 15 percent growth was applied to the current counts to derive future projections.

4. Improvement Alternatives

Based on the previous planning documents and existing conditions data reviewed, four alternatives were developed to improve traffic operations and bicycle and pedestrian facilities in the Triangle area. These alternatives are described below.

4.1 Alternative 1

Alternative 1 creates an oblong roundabout at the Triangle, combining Neal Street, SR 174, Tinloy Street, Hansen Way, and South Auburn Street into a single large intersection. It would require additional right-of-way from the Safeway shopping center parcel as well as from a property owner on the southeast corner.

4.2 Alternative 2

Alternative 2 also creates a roundabout at the Triangle, but avoids right of way impacts to adjacent properties. To achieve this, South Auburn Street north of Neal Street would be restricted to right-in and right-out only. New sidewalk would be provided on the south side of Hansen Way.

4.3 Alternative 3

Alternative 3 makes no changes to existing intersection geometries, but provides new bicycling and walking facilities through the complex area. Bicycle lanes would be provided on SR 174, with green markings through potential conflict areas with motor vehicles. A two-way protected bikeway would be provided on the south side of Hansen Way to connect SR 174 to South Auburn Way. High visibility crosswalk markings would improve crossing safety for pedestrians.

4.4 Alternative 4

Alternative 4 includes an oblong roundabout similar to Alternative 1, but retains signalized intersections on South Auburn Street at Tinloy Street and at Neal Street. No additional right-of-way would be required. Traffic operations may be unacceptable due to the close spacing of these intersections, and vehicle queues may back up into the roundabout.



4.5 Comparison of Alternatives 1-4

Improvements recommended in this study are intended to address four needs in the Triangle area. Alternatives were compared to see how well they balanced these four objectives: improving safety for all users, providing acceptable traffic operations, supporting a safe and comfortable bicycling and walking environment, and avoiding right-of-way impacts to private property owners. Table 4.1 summarizes this comparison. Alternative 1 is the only one to provide acceptable traffic operations, but fails to avoid right-of-way impacts. Neither Alternative 1 nor 4 improves bicycling and walking conditions.

Table 4.1 Comparison of Alternatives 1-4

Alternative	Improves Safety	Acceptable Traffic Operations	Supports Bicycling & Walking	Does Not Require Right of Way
Alternative 1	●	●		
Alternative 2	●		●	●
Alternative 3	●		●	●
Alternative 4	●			●

Because no proposed alternative fulfills all four criteria, a fifth alternative was developed that incorporates successful elements from previous alternatives.

4.6 Alternative 5

The fifth alternative includes an oblong-shaped roundabout similar to Alternative 1, creating one large intersection with the existing parking lot preserved in the center. The intersection of Colfax Avenue and Hansen Way remains a standard T-intersection, reducing the impacts to private property on the south side of Colfax Avenue. Improvements for bicycle and pedestrian circulation are incorporated throughout the project area. The fifth alternative successfully meets all four objectives identified in Table 4.1. Appendix B includes the concept and the associated design check exhibits.

5. Recommended Improvements (build alternative)

Recommended improvement concept for the ultimate SR 174/SR 20 intersection includes:

- Oblong, peanut-shaped roundabout to improve traffic operations and simplify circulation by combining multiple intersections
- High visibility marked crosswalks across all roundabout entry and exit lanes and at Colfax Avenue and Hansen Street
- High visibility marked crosswalks across the circulating road to provide pedestrian access to the parking lot under SR 20
- Shared-use paths around the project intersection to provide separate, dedicated space for people walking and bicycling



- The ramp has higher volumes than the side street provides and is currently controlled by a stop sign. Add a stop sign on the leg of South Auburn Street in front of the school. An all-way stop is not recommended as it would clog the signals today and the roundabout in the future. Move the stop bar closer to the intersection, and shrink the size of the KEEP CLEAR zone which would help with two things:
 - It puts the drivers on the off-ramp and the drivers on South Auburn Street much closer together, so eye contact and communication will be better.
 - It puts the drivers leaving the half-circle driveway in front of the school behind the stop bar, so there is less possibility of miscommunication with ramp traffic and South Auburn Street traffic.

5.1 Future Traffic Operations

Two scenarios were evaluated for future traffic operations: cumulative conditions if no project is implemented (no build alternative), and cumulative conditions if the preferred alternative is implemented. For both scenarios, only the PM peak hour was analyzed. Existing AM peak hour volumes are significantly lower than the PM peak hour, indicating the PM peak hour operations would be the limiting condition in a future scenario. Future operations with no project were modeled in Synchro for all intersections. Future operations with the preferred project alternative were modeled using VISSIM with the exception of intersection 1, which was modeled using Synchro.

Table 5.1 presents future traffic operations under cumulative conditions with no project, and Table 5.2 presents future operations if the recommended alternative is implemented. The ramp intersection is expected to operate with significant delays and queues. Although the LOS is within the acceptable ranges for majority of the intersections, the vehicular queues at the signalized intersections are expected to spill back into the adjacent intersections.

When compared to the No Project scenario, the With Project scenario is expected to provide improved operations and safety across the entire network of intersections.

Table 5.1 Cumulative Conditions No Project

#	Intersection	Control Type ^{1,2}	PM Peak Hour	
			Delay	LOS
1	Auburn Street & Hansen Way/EB Off-Ramp	OWSC	OVR	F
2	Auburn Street & Tinloy Street/WB On-Ramp	Signal	11.3	B
3	Auburn Street & Neal Street	Signal	18.0	B
4	Tinloy Street & Colfax Avenue	Signal	20.8	C
5	Hansen Way & Colfax Avenue/SR 174	TWSC	14.1	B



Table 5.2 Cumulative Conditions with Project

#	Intersection	Control Type ^{1,2}	PM Peak Hour	
			Delay	LOS
1	Auburn Street & Hansen Way/EB Off-Ramp	TWSC	48.9	E
2	Auburn Street & Tinloy Street/WB On-Ramp	RNDBT	3.4	A
3	Auburn Street & Neal Street	Signal	9.1	A
4	Tinloy Street & Colfax Avenue	RNDBT	17.5	B
5	Hansen Way & Colfax Avenue/SR 174	TWSC	16.4	C
6	Full Roundabout	RNDBT	6.4	A

5.2 Collision Costs

Costs associated with collisions anticipated for each proposed intersection improvement were quantified using the Caltrans Intersection Control Evaluation Collision Cost Analysis spreadsheet.

- Over the life of the project, the collision cost for no build conditions are expected to be \$5.2 million.
- With the proposed improvement, the collision cost is expected to be \$1.25 million.

5.3 Delay Costs

To calculate the delay costs for the two alternatives, the value of travel time was quantified for each proposed alternative. The delay costs were computed using the delay for the AM and PM peak hour periods of both the Alternatives. In assessing the delay costs, the weighted-average for costing the value of time for automobiles and trucks was used.

An average delay cost of \$18.95/person hours is published data by Caltrans for Vehicle Operation Costs Parameters for 2016 (http://www.dot.ca.gov/hq/tpp/offices/eab/benefit_cost/LCBCA-economic_parameters.html). This rate was adjusted to better represent local factors.

- Over the life of the project, the delay cost for no build conditions are expected to be \$6.5 million.
- With the proposed improvement, the delay cost is expected to be \$2.3 million.

5.4 Other Costs

Operation and maintenance costs are other important components of the cost associated within both alternatives. The operation and maintenance costs for a traffic signal include providing power service to the signal and street lighting (\$600/year), signal retiming (\$500/year), and signal maintenance for power outages/new detector loops/etc. (\$10,000/year).

The roundabout alternative would have lower operation and maintenance costs that are limited to power street lighting (\$250/year). These values are typical industry averages.



Table 5.3 provides the benefit cost ratio for the roundabout alternative when compared to the no-build alternative, while Table 5.4 provides the life cycle costs for the roundabout alternative when compared to the no-build alternative.

Table 5.3 Benefit costs

Roundabout Alt vs. No Build Alt	
<i>Safety Benefit</i>	\$3,950,600
<i>Delay Reduction Benefit</i>	\$4,210,000
Total Benefits	\$8,160,600
<i>Operations&Maintenance Costs</i>	\$ 411,000
<i>Added Capital Costs</i>	\$5,309,000
Total Costs	\$4,898,000
Life Cycle Benefit/Cost Ratio	1.7

Table 5.4 Summary of Life Cycle Costs

Roundabout Alternative to No Build Alternative		
Life Cycle Costs	Roundabout	No Build
Collision and Mobility Costs		
Collision Costs of predicted crashes	\$1,247,800	\$5,198,400
Delay Costs	\$2,330,000	\$6,540,000
Project Costs including Design, Construction, and Maintenance		
Operations and Maintenance Costs	\$75,000	\$486,000
Project Costs	\$5,309,000	\$0
Total Life Cycle Costs	\$8,961,800	\$12,224,400

6. Conclusion

Two alternatives have been identified for the study intersections, no-build and build alternative. The overall life cycle cost of the build alternative is lower when compared to the no-build alternative. The build alternative provides significant savings occur in predicted future collisions and delay cost. The build alternative improves operations and safety for non-motorized traffic and the feedback from the public workshops and agency for the build alternative is extremely positive. Therefore, this study recommends that the build alternative be advanced to the next project development phase.



about GHD

GHD is one of the world's leading professional services companies operating in the global markets of water, energy and resources, environment, property and buildings, and transportation. We provide engineering, environmental, and construction services to private and public sector clients.

Todd Tregenza, AICP
Todd.Tregenza@ghd.com
916.865.0935

Kamesh Vedula, PE, TE
Kamesh.Vedula@ghd.com
916.782.8688

www.ghd.com

APPENDIX A

HCM 6th TWSC
1: S Auburn St & EB Off Ramp/Hansen Way

Existing Conditions
AM Peak Hour

Intersection													
Int Delay, s/veh	8.3												
Movement	EBL	EBT	EBR	WBL	WBT	WBR	NBU	NBL	NBT	NBR	SBL	SBT	SBR
Lane Configurations		↔	↔						↔			↔	
Traffic Vol, veh/h	143	89	64	0	0	0	1	0	214	170	2	228	0
Future Vol, veh/h	143	89	64	0	0	0	1	0	214	170	2	228	0
Conflicting Peds, #/hr	0	0	1	1	0	0	1	9	0	103	103	0	9
Sign Control	Stop	Stop	Stop	Stop	Stop	Stop	Free	Free	Free	Free	Free	Free	Free
RT Channelized	-	-	Stop	-	-	None	-	-	-	None	-	-	None
Storage Length	-	-	140	-	-	-	-	-	-	-	-	-	-
Veh in Median Storage, #	-	0	-	-	16979	-	-	-	0	-	-	0	-
Grade, %	-	0	-	-	0	-	-	-	0	-	-	0	-
Peak Hour Factor	79	79	79	79	79	79	79	79	92	79	79	79	79
Heavy Vehicles, %	3	3	3	3	3	3	3	3	3	3	3	3	3
Mvmt Flow	181	113	81	0	0	0	1	0	233	215	3	289	0

Major/Minor	Minor2			Major1			Major2			
Conflicting Flow All	636	848	290	-	-	0	0	551	0	0
Stage 1	295	295	-	-	-	-	-	-	-	-
Stage 2	341	553	-	-	-	-	-	-	-	-
Critical Hdwy	6.43	6.53	6.23	-	-	-	-	4.13	-	-
Critical Hdwy Stg 1	5.43	5.53	-	-	-	-	-	-	-	-
Critical Hdwy Stg 2	5.43	5.53	-	-	-	-	-	-	-	-
Follow-up Hdwy	3.527	4.027	3.327	-	-	-	-	2.227	-	-
Pot Cap-1 Maneuver	440	297	747	-	0	-	-	1014	-	0
Stage 1	753	667	-	-	0	-	-	-	-	0
Stage 2	718	513	-	-	0	-	-	-	-	0
Platoon blocked, %										
Mov Cap-1 Maneuver	438	0	746	-	-	-	-	1014	-	-
Mov Cap-2 Maneuver	438	0	-	-	-	-	-	-	-	-
Stage 1	753	0	-	-	-	-	-	-	-	-
Stage 2	715	0	-	-	-	-	-	-	-	-

Approach	EB	NB	SB
HCM Control Delay, s	24.5		0.1
HCM LOS	C		

Minor Lane/Major Mvmt	NBT	NBR	EBLn1	EBLn2	SBL	SBT
Capacity (veh/h)	-	-	438	746	1014	-
HCM Lane V/C Ratio	-	-	0.67	0.109	0.002	-
HCM Control Delay (s)	-	-	28.4	10.4	8.6	0
HCM Lane LOS	-	-	D	B	A	A
HCM 95th %tile Q(veh)	-	-	4.8	0.4	0	-

HCM Signalized Intersection Capacity Analysis

2: S Auburn St & WB On Ramp/Tinloy St

Existing Conditions
AM Peak Hour



Movement	EBL	EBT	EBR	WBL	WBT	WBR	NBL	NBT	NBR	SBL	SBT	SBR	
Lane Configurations					↕↕			↕↕			↕		
Traffic Volume (vph)	0	0	0	97	172	0	44	313	0	0	133	138	
Future Volume (vph)	0	0	0	97	172	0	44	313	0	0	133	138	
Ideal Flow (vphpl)	1900	1900	1900	1900	1900	1900	1900	1900	1900	1900	1900	1900	
Total Lost time (s)					3.6			3.6			3.6		
Lane Util. Factor					0.95			0.95			1.00		
Frbp, ped/bikes					1.00			1.00			0.98		
Flpb, ped/bikes					1.00			1.00			1.00		
Frt					1.00			1.00			0.93		
Flt Protected					0.98			0.99			1.00		
Satd. Flow (prot)					3443			3481			1689		
Flt Permitted					0.98			0.60			1.00		
Satd. Flow (perm)					3443			2092			1689		
Peak-hour factor, PHF	0.92	0.92	0.92	0.92	0.92	0.92	0.92	0.92	0.92	0.92	0.92	0.92	
Adj. Flow (vph)	0	0	0	105	187	0	48	340	0	0	145	150	
RTOR Reduction (vph)	0	0	0	0	0	0	0	0	0	0	49	0	
Lane Group Flow (vph)	0	0	0	0	292	0	0	388	0	0	246	0	
Confl. Peds. (#/hr)							9		11	11		9	
Heavy Vehicles (%)	3%	3%	3%	3%	3%	3%	3%	3%	3%	3%	3%	3%	
Turn Type				Perm	NA		Perm	NA			NA		
Protected Phases					7			2 6			6 8		
Permitted Phases				7			2 6						
Actuated Green, G (s)					11.8			18.7			39.7		
Effective Green, g (s)					11.8			18.7			39.7		
Actuated g/C Ratio					0.20			0.32			0.68		
Clearance Time (s)					3.6								
Vehicle Extension (s)					2.0								
Lane Grp Cap (vph)					692			666			1142		
v/s Ratio Prot											c0.15		
v/s Ratio Perm					0.08			c0.19					
v/c Ratio					0.42			0.58			0.22		
Uniform Delay, d1					20.5			16.7			3.6		
Progression Factor					0.81			1.00			0.02		
Incremental Delay, d2					0.1			0.8			0.0		
Delay (s)					16.8			17.6			0.1		
Level of Service					B			B			A		
Approach Delay (s)		0.0			16.8			17.6			0.1		
Approach LOS		A			B			B			A		
Intersection Summary													
HCM 2000 Control Delay			12.1		HCM 2000 Level of Service						B		
HCM 2000 Volume to Capacity ratio			0.41										
Actuated Cycle Length (s)			58.7		Sum of lost time (s)						10.8		
Intersection Capacity Utilization			43.6%		ICU Level of Service						A		
Analysis Period (min)			15										
c Critical Lane Group													

HCM Signalized Intersection Capacity Analysis

3: S Auburn St & Neal St

Existing Conditions













AM Peak Hour

Movement	EBL	EBT	EBR	WBL	WBT	WBR	NBL	NBT	NBR	SBL	SBT	SBR
Lane Configurations												
Traffic Volume (vph)	20	177	99	0	159	85	77	235	1	44	172	30
Future Volume (vph)	20	177	99	0	159	85	77	235	1	44	172	30
Ideal Flow (vphpl)	1900	1900	1900	1900	1900	1900	1900	1900	1900	1900	1900	1900
Total Lost time (s)	3.6	3.6			3.6	3.6	3.6	3.6		3.6	3.6	
Lane Util. Factor	1.00	1.00			1.00	1.00	1.00	1.00		1.00	1.00	
Frbp, ped/bikes	1.00	0.99			1.00	0.98	1.00	1.00		1.00	1.00	
Flpb, ped/bikes	1.00	1.00			1.00	1.00	1.00	1.00		1.00	1.00	
Frt	1.00	0.95			1.00	0.85	1.00	1.00		1.00	0.98	
Flt Protected	0.95	1.00			1.00	1.00	0.95	1.00		0.95	1.00	
Satd. Flow (prot)	1767	1738			1863	1549	1762	1862		1765	1814	
Flt Permitted	0.64	1.00			1.00	1.00	0.55	1.00		0.49	1.00	
Satd. Flow (perm)	1199	1738			1863	1549	1011	1862		911	1814	
Peak-hour factor, PHF	0.89	0.89	0.89	0.89	0.89	0.89	0.89	0.89	0.89	0.89	0.89	0.89
Adj. Flow (vph)	22	199	111	0	179	96	87	264	1	49	193	34
RTOR Reduction (vph)	0	26	0	0	0	42	0	0	0	0	9	0
Lane Group Flow (vph)	22	284	0	0	179	54	87	265	0	49	218	0
Confl. Peds. (#/hr)	1		12	12		1	4		3	3		4
Turn Type	Perm	NA			NA	Perm	Perm	NA		Perm	NA	
Protected Phases		8			8	7		2	6		6	
Permitted Phases	8					8	2		6			
Actuated Green, G (s)	17.4	17.4			32.8	32.8	18.7	18.7		18.7	18.7	
Effective Green, g (s)	17.4	17.4			32.8	32.8	18.7	18.7		18.7	18.7	
Actuated g/C Ratio	0.30	0.30			0.56	0.56	0.32	0.32		0.32	0.32	
Clearance Time (s)	3.6	3.6								3.6	3.6	
Vehicle Extension (s)	2.0	2.0								2.0	2.0	
Lane Grp Cap (vph)	355	515			1040	865	322	593		290	577	
v/s Ratio Prot		c0.16			c0.10			c0.14			0.12	
v/s Ratio Perm	0.02					0.03	0.09			0.05		
v/c Ratio	0.06	0.55			0.17	0.06	0.27	0.45		0.17	0.38	
Uniform Delay, d1	14.8	17.4			6.3	5.9	14.9	15.9		14.4	15.5	
Progression Factor	1.00	1.00			0.46	0.38	0.18	0.17		1.00	1.00	
Incremental Delay, d2	0.0	0.7			0.0	0.0	0.2	0.2		0.1	0.2	
Delay (s)	14.8	18.1			2.9	2.2	2.8	2.9		14.5	15.6	
Level of Service	B	B			A	A	A	A		B	B	
Approach Delay (s)		17.9			2.7			2.9			15.4	
Approach LOS		B			A			A			B	
Intersection Summary												
HCM 2000 Control Delay			9.7								HCM 2000 Level of Service	A
HCM 2000 Volume to Capacity ratio			0.42									
Actuated Cycle Length (s)			58.7								Sum of lost time (s)	10.8
Intersection Capacity Utilization			46.6%								ICU Level of Service	A
Analysis Period (min)			15									
c	Critical Lane Group											

HCM Signalized Intersection Capacity Analysis

4: Tinloy St & Neal St

Existing Conditions
AM Peak Hour

												
Movement	EBL	EBT	EBR	WBL	WBT	WBR	NBL	NBT	NBR	SBL	SBT	SBR
Lane Configurations		↑			↔						↕	↕
Traffic Volume (vph)	0	213	9	103	180	0	0	0	0	70	157	64
Future Volume (vph)	0	213	9	103	180	0	0	0	0	70	157	64
Ideal Flow (vphp)	1900	1900	1900	1900	1900	1900	1900	1900	1900	1900	1900	1900
Total Lost time (s)		3.6			3.6						3.6	
Lane Util. Factor		1.00			1.00						0.95	
Frbp, ped/bikes		1.00			1.00						1.00	
Flpb, ped/bikes		1.00			1.00						1.00	
Frt		0.99			1.00						0.97	
Flt Protected		1.00			0.98						0.99	
Satd. Flow (prot)		1851			1827						3382	
Flt Permitted		1.00			0.80						0.99	
Satd. Flow (perm)		1851			1482						3382	
Peak-hour factor, PHF	0.91	0.91	0.91	0.91	0.91	0.91	0.91	0.91	0.91	0.91	0.91	0.91
Adj. Flow (vph)	0	234	10	113	198	0	0	0	0	77	173	70
RTOR Reduction (vph)	0	2	0	0	0	0	0	0	0	0	35	0
Lane Group Flow (vph)	0	242	0	0	311	0	0	0	0	0	285	0
Confl. Peds. (#/hr)	5		6	6		5						
Turn Type		NA		Perm	NA						Perm	NA
Protected Phases		8 6			8						7	
Permitted Phases				8						7		
Actuated Green, G (s)		39.7			17.4						11.8	
Effective Green, g (s)		39.7			17.4						11.8	
Actuated g/C Ratio		0.68			0.30						0.20	
Clearance Time (s)					3.6						3.6	
Vehicle Extension (s)					2.0						2.0	
Lane Grp Cap (vph)		1251			439						679	
v/s Ratio Prot		c0.13										
v/s Ratio Perm					c0.21						0.08	
v/c Ratio		0.19			0.71						0.42	
Uniform Delay, d1		3.5			18.4						20.5	
Progression Factor		0.14			1.00						1.00	
Incremental Delay, d2		0.0			4.2						0.2	
Delay (s)		0.5			22.6						20.6	
Level of Service		A			C						C	
Approach Delay (s)		0.5			22.6			0.0			20.6	
Approach LOS		A			C			A			C	
Intersection Summary												
HCM 2000 Control Delay			15.7			HCM 2000 Level of Service				B		
HCM 2000 Volume to Capacity ratio			0.45									
Actuated Cycle Length (s)			58.7			Sum of lost time (s)			10.8			
Intersection Capacity Utilization			46.0%			ICU Level of Service			A			
Analysis Period (min)			15									
c Critical Lane Group												

Intersection												
Intersection Delay, s/veh 14.3												
Intersection LOS B												

Movement	EBL	EBT	EBR	WBL	WBT	WBR	NBL	NBT	NBR	SBL	SBT	SBR
Lane Configurations		↔			↔			↔↔				
Traffic Vol, veh/h	86	197	0	0	278	88	5	149	107	0	0	0
Future Vol, veh/h	86	197	0	0	278	88	5	149	107	0	0	0
Peak Hour Factor	0.86	0.86	0.86	0.86	0.86	0.86	0.86	0.86	0.86	0.86	0.86	0.86
Heavy Vehicles, %	3	3	3	3	3	3	3	3	3	3	3	3
Mvmt Flow	100	229	0	0	323	102	6	173	124	0	0	0
Number of Lanes	0	1	0	0	1	0	0	2	0	0	0	0

Approach	EB	WB	NB
Opposing Approach	WB	EB	
Opposing Lanes	1	1	0
Conflicting Approach Left		NB	EB
Conflicting Lanes Left	0	2	1
Conflicting Approach Right	NB		WB
Conflicting Lanes Right	2	0	1
HCM Control Delay	14.1	16.2	11.7
HCM LOS	B	C	B

Lane	NBLn1	NBLn2	EBLn1	WBLn1
Vol Left, %	6%	0%	30%	0%
Vol Thru, %	94%	41%	70%	76%
Vol Right, %	0%	59%	0%	24%
Sign Control	Stop	Stop	Stop	Stop
Traffic Vol by Lane	80	182	283	366
LT Vol	5	0	86	0
Through Vol	75	75	197	278
RT Vol	0	107	0	88
Lane Flow Rate	92	211	329	426
Geometry Grp	7	7	2	2
Degree of Util (X)	0.168	0.356	0.504	0.614
Departure Headway (Hd)	6.525	6.073	5.518	5.198
Convergence, Y/N	Yes	Yes	Yes	Yes
Cap	550	591	652	694
Service Time	4.266	3.814	3.558	3.235
HCM Lane V/C Ratio	0.167	0.357	0.505	0.614
HCM Control Delay	10.6	12.2	14.1	16.2
HCM Lane LOS	B	B	B	C
HCM 95th-tile Q	0.6	1.6	2.8	4.2

Intersection												
Intersection Delay, s/veh	8.9											
Intersection LOS	A											

Movement	EBL	EBT	EBR	WBL	WBT	WBR	NBL	NBT	NBR	SBL	SBT	SBR
Lane Configurations		↔			↔			↔				
Traffic Vol, veh/h	41	5	0	0	39	3	19	298	6	0	0	0
Future Vol, veh/h	41	5	0	0	39	3	19	298	6	0	0	0
Peak Hour Factor	0.87	0.87	0.87	0.87	0.87	0.87	0.87	0.87	0.87	0.87	0.87	0.87
Heavy Vehicles, %	2	2	2	2	2	2	2	2	2	2	2	2
Mvmt Flow	47	6	0	0	45	3	22	343	7	0	0	0
Number of Lanes	0	1	0	0	1	0	0	2	0	0	0	0

Approach	EB	WB	NB
Opposing Approach	WB	EB	
Opposing Lanes	1	1	0
Conflicting Approach Left		NB	EB
Conflicting Lanes Left	0	2	1
Conflicting Approach Right	NB		WB
Conflicting Lanes Right	2	0	1
HCM Control Delay	8.4	8.1	9.1
HCM LOS	A	A	A

Lane	NBLn1	NBLn2	EBLn1	WBLn1
Vol Left, %	11%	0%	89%	0%
Vol Thru, %	89%	96%	11%	93%
Vol Right, %	0%	4%	0%	7%
Sign Control	Stop	Stop	Stop	Stop
Traffic Vol by Lane	168	155	46	42
LT Vol	19	0	41	0
Through Vol	149	149	5	39
RT Vol	0	6	0	3
Lane Flow Rate	193	178	53	48
Geometry Grp	7	7	2	2
Degree of Util (X)	0.256	0.232	0.074	0.064
Departure Headway (Hd)	4.766	4.682	5.011	4.798
Convergence, Y/N	Yes	Yes	Yes	Yes
Cap	743	757	719	750
Service Time	2.558	2.475	3.014	2.802
HCM Lane V/C Ratio	0.26	0.235	0.074	0.064
HCM Control Delay	9.2	8.9	8.4	8.1
HCM Lane LOS	A	A	A	A
HCM 95th-tile Q	1	0.9	0.2	0.2

Intersection

Intersection Delay, s/veh	9.2
Intersection LOS	A

Movement	EBL	EBT	EBR	WBL	WBT	WBR	NBL	NBT	NBR	SBL	SBT	SBR
Lane Configurations		↻			↻						↻↻	
Traffic Vol, veh/h	0	43	10	12	46	0	0	0	0	3	269	55
Future Vol, veh/h	0	43	10	12	46	0	0	0	0	3	269	55
Peak Hour Factor	0.78	0.78	0.78	0.78	0.78	0.78	0.78	0.78	0.78	0.78	0.78	0.78
Heavy Vehicles, %	2	2	2	2	2	2	2	2	2	2	2	2
Mvmt Flow	0	55	13	15	59	0	0	0	0	4	345	71
Number of Lanes	0	1	0	0	1	0	0	0	0	0	2	0

Approach	EB	WB	SB
Opposing Approach	WB	EB	
Opposing Lanes	1	1	0
Conflicting Approach Left	SB		WB
Conflicting Lanes Left	2	0	1
Conflicting Approach Right		SB	EB
Conflicting Lanes Right	0	2	1
HCM Control Delay	8.3	8.6	9.4
HCM LOS	A	A	A

Lane	EBLn1	WBLn1	SBLn1	SBLn2
Vol Left, %	0%	21%	2%	0%
Vol Thru, %	81%	79%	98%	71%
Vol Right, %	19%	0%	0%	29%
Sign Control	Stop	Stop	Stop	Stop
Traffic Vol by Lane	53	58	138	190
LT Vol	0	12	3	0
Through Vol	43	46	135	135
RT Vol	10	0	0	55
Lane Flow Rate	68	74	176	243
Geometry Grp	2	2	7	7
Degree of Util (X)	0.091	0.103	0.24	0.316
Departure Headway (Hd)	4.84	4.984	4.898	4.684
Convergence, Y/N	Yes	Yes	Yes	Yes
Cap	741	720	735	768
Service Time	2.863	3.007	2.619	2.405
HCM Lane V/C Ratio	0.092	0.103	0.239	0.316
HCM Control Delay	8.3	8.6	9.2	9.6
HCM Lane LOS	A	A	A	A
HCM 95th-tile Q	0.3	0.3	0.9	1.4

HCM 6th TWSC
1: S Auburn St & EB Off Ramp/Hansen Way

Existing Conditions
PM Peak Hour

Intersection												
Int Delay, s/veh	8.1											
Movement	EBL	EBT	EBR	WBL	WBT	WBR	NBL	NBT	NBR	SBL	SBT	SBR
Lane Configurations		↔	↔					↔			↔	
Traffic Vol, veh/h	214	86	41	0	0	0	0	183	142	5	251	0
Future Vol, veh/h	214	86	41	0	0	0	0	183	142	5	251	0
Conflicting Peds, #/hr	0	0	0	0	0	0	13	0	9	9	0	19
Sign Control	Stop	Stop	Stop	Stop	Stop	Stop	Free	Free	Free	Free	Free	Free
RT Channelized	-	-	Stop	-	-	None	-	-	None	-	-	None
Storage Length	-	-	140	-	-	-	-	-	-	-	-	-
Veh in Median Storage, #	-	0	-	-	16979	-	-	0	-	-	0	-
Grade, %	-	0	-	-	0	-	-	0	-	-	0	-
Peak Hour Factor	96	96	96	96	96	96	96	96	96	96	96	96
Heavy Vehicles, %	2	2	2	2	2	2	2	2	2	2	2	2
Mvmt Flow	223	90	43	0	0	0	0	191	148	5	261	0

Major/Minor	Minor2			Major1			Major2		
Conflicting Flow All	536	619	261	-	0	0	348	0	0
Stage 1	271	271	-	-	-	-	-	-	-
Stage 2	265	348	-	-	-	-	-	-	-
Critical Hdwy	6.42	6.52	6.22	-	-	-	4.12	-	-
Critical Hdwy Stg 1	5.42	5.52	-	-	-	-	-	-	-
Critical Hdwy Stg 2	5.42	5.52	-	-	-	-	-	-	-
Follow-up Hdwy	3.518	4.018	3.318	-	-	-	2.218	-	-
Pot Cap-1 Maneuver	505	404	778	0	-	-	1211	-	0
Stage 1	775	685	-	0	-	-	-	-	0
Stage 2	779	634	-	0	-	-	-	-	0
Platoon blocked, %									
Mov Cap-1 Maneuver	502	0	778	-	-	-	1211	-	-
Mov Cap-2 Maneuver	502	0	-	-	-	-	-	-	-
Stage 1	775	0	-	-	-	-	-	-	-
Stage 2	775	0	-	-	-	-	-	-	-

















Approach	EB	NB	SB
HCM Control Delay, s	21.7	0	0.2
HCM LOS	C		

Minor Lane/Major Mvmt	NBT	NBR	EBLn1	EBLn2	SBL	SBT
Capacity (veh/h)	-	-	502	778	1211	-
HCM Lane V/C Ratio	-	-	0.623	0.055	0.004	-
HCM Control Delay (s)	-	-	23.3	9.9	8	0
HCM Lane LOS	-	-	C	A	A	A
HCM 95th %tile Q(veh)	-	-	4.2	0.2	0	-

HCM Signalized Intersection Capacity Analysis

2: S Auburn St & WB On Ramp/Tinloy St

Existing Conditions
PM Peak Hour

												
Movement	EBL	EBT	EBR	WBL	WBT	WBR	NBL	NBT	NBR	SBL	SBT	SBR
Lane Configurations					 			 				
Traffic Volume (vph)	0	0	0	105	234	0	29	368	0	0	151	215
Future Volume (vph)	0	0	0	105	234	0	29	368	0	0	151	215
Ideal Flow (vphp)	1900	1900	1900	1900	1900	1900	1900	1900	1900	1900	1900	1900
Total Lost time (s)					3.6			3.6			3.6	
Lane Util. Factor					0.95			0.95			1.00	
Frbp, ped/bikes					1.00			1.00			0.97	
Flpb, ped/bikes					1.00			1.00			1.00	
Frt					1.00			1.00			0.92	
Flt Protected					0.98			1.00			1.00	
Satd. Flow (prot)					3485			3524			1669	
Flt Permitted					0.98			0.65			1.00	
Satd. Flow (perm)					3485			2289			1669	
Peak-hour factor, PHF	0.91	0.91	0.91	0.91	0.91	0.91	0.91	0.91	0.91	0.91	0.91	0.91
Adj. Flow (vph)	0	0	0	115	257	0	32	404	0	0	166	236
RTOR Reduction (vph)	0	0	0	0	0	0	0	0	0	0	72	0
Lane Group Flow (vph)	0	0	0	0	372	0	0	436	0	0	330	0
Confl. Peds. (#/hr)							17		10	10		17
Turn Type				Perm	NA		Perm	NA			NA	
Protected Phases					7			2 6			6 8	
Permitted Phases				7			2 6					
Actuated Green, G (s)					13.1			19.8			40.8	
Effective Green, g (s)					13.1			19.8			40.8	
Actuated g/C Ratio					0.21			0.32			0.67	
Clearance Time (s)					3.6							
Vehicle Extension (s)					2.0							
Lane Grp Cap (vph)					747			741			1114	
v/s Ratio Prot											c0.20	
v/s Ratio Perm					0.11			c0.19				
v/c Ratio					0.50			0.59			0.30	
Uniform Delay, d1					21.1			17.2			4.2	
Progression Factor					0.70			1.00			0.01	
Incremental Delay, d2					0.2			0.8			0.0	
Delay (s)					14.8			18.0			0.1	
Level of Service					B			B			A	
Approach Delay (s)		0.0			14.8			18.0			0.1	
Approach LOS		A			B			B			A	
Intersection Summary												
HCM 2000 Control Delay			11.1		HCM 2000 Level of Service						B	
HCM 2000 Volume to Capacity ratio			0.47									
Actuated Cycle Length (s)			61.1		Sum of lost time (s)					10.8		
Intersection Capacity Utilization			48.5%		ICU Level of Service					A		
Analysis Period (min)			15									
c Critical Lane Group												

HCM Signalized Intersection Capacity Analysis

3: S Auburn St & Neal St

Existing Conditions

PM Peak Hour

















Movement	EBL	EBT	EBR	WBL	WBT	WBR	NBL	NBT	NBR	SBL	SBT	SBR	
Lane Configurations													
Traffic Volume (vph)	42	201	160	0	202	77	108	258	2	49	206	75	
Future Volume (vph)	42	201	160	0	202	77	108	258	2	49	206	75	
Ideal Flow (vphpl)	1900	1900	1900	1900	1900	1900	1900	1900	1900	1900	1900	1900	
Total Lost time (s)	3.6	3.6			3.6	3.6	3.6	3.6		3.6	3.6		
Lane Util. Factor	1.00	1.00			1.00	1.00	1.00	1.00		1.00	1.00		
Frbp, ped/bikes	1.00	0.98			1.00	0.96	1.00	1.00		1.00	0.99		
Flpb, ped/bikes	0.99	1.00			1.00	1.00	0.99	1.00		0.99	1.00		
Frt	1.00	0.93			1.00	0.85	1.00	1.00		1.00	0.96		
Flt Protected	0.95	1.00			1.00	1.00	0.95	1.00		0.95	1.00		
Satd. Flow (prot)	1749	1709			1863	1526	1747	1860		1758	1769		
Flt Permitted	0.63	1.00			1.00	1.00	0.46	1.00		0.49	1.00		
Satd. Flow (perm)	1156	1709			1863	1526	839	1860		898	1769		
Peak-hour factor, PHF	0.97	0.97	0.97	0.97	0.97	0.97	0.97	0.97	0.97	0.97	0.97	0.97	
Adj. Flow (vph)	43	207	165	0	208	79	111	266	2	51	212	77	
RTOR Reduction (vph)	0	39	0	0	0	35	0	1	0	0	18	0	
Lane Group Flow (vph)	43	333	0	0	208	44	111	267	0	51	271	0	
Confl. Peds. (#/hr)	9		11	11		9	14		7	7		14	
Confl. Bikes (#/hr)						2							
Turn Type	Perm	NA			NA	Perm	Perm	NA		Perm	NA		
Protected Phases		8			8	7		2	6		6		
Permitted Phases	8					8	7	2	6				
Actuated Green, G (s)	17.4	17.4			34.1	34.1	19.8	19.8		19.8	19.8		
Effective Green, g (s)	17.4	17.4			34.1	34.1	19.8	19.8		19.8	19.8		
Actuated g/C Ratio	0.28	0.28			0.56	0.56	0.32	0.32		0.32	0.32		
Clearance Time (s)	3.6	3.6								3.6	3.6		
Vehicle Extension (s)	2.0	2.0								2.0	2.0		
Lane Grp Cap (vph)	329	486			1039	851	271	602		291	573		
v/s Ratio Prot		c0.20			c0.11			0.14			c0.15		
v/s Ratio Perm	0.04					0.03	0.13			0.06			
v/c Ratio	0.13	0.69			0.20	0.05	0.41	0.44		0.18	0.47		
Uniform Delay, d1	16.2	19.4			6.7	6.1	16.1	16.3		14.8	16.5		
Progression Factor	1.00	1.00			0.34	0.19	0.14	0.14		1.00	1.00		
Incremental Delay, d2	0.1	3.2			0.0	0.0	0.3	0.2		0.1	0.2		
Delay (s)	16.3	22.6			2.3	1.2	2.5	2.5		14.9	16.7		
Level of Service	B	C			A	A	A	A		B	B		
Approach Delay (s)		22.0			2.0			2.5			16.4		
Approach LOS		C			A			A			B		
Intersection Summary													
HCM 2000 Control Delay			11.4									HCM 2000 Level of Service	B
HCM 2000 Volume to Capacity ratio			0.48										
Actuated Cycle Length (s)			61.1									Sum of lost time (s)	10.8
Intersection Capacity Utilization			56.2%									ICU Level of Service	B
Analysis Period (min)			15										

c Critical Lane Group

HCM Signalized Intersection Capacity Analysis

4: Tinloy St & Neal St

Existing Conditions
PM Peak Hour

												
Movement	EBL	EBT	EBR	WBL	WBT	WBR	NBL	NBT	NBR	SBL	SBT	SBR
Lane Configurations												
Traffic Volume (vph)	0	251	1	99	153	0	0	0	0	54	239	126
Future Volume (vph)	0	251	1	99	153	0	0	0	0	54	239	126
Ideal Flow (vphpl)	1900	1900	1900	1900	1900	1900	1900	1900	1900	1900	1900	1900
Total Lost time (s)		3.6			3.6						3.6	
Lane Util. Factor		1.00			1.00						0.95	
Frbp, ped/bikes		1.00			1.00						1.00	
Flpb, ped/bikes		1.00			1.00						1.00	
Frt		1.00			1.00						0.95	
Flt Protected		1.00			0.98						0.99	
Satd. Flow (prot)		1862			1823						3358	
Flt Permitted		1.00			0.78						0.99	
Satd. Flow (perm)		1862			1446						3358	
Peak-hour factor, PHF	0.95	0.95	0.95	0.95	0.95	0.95	0.95	0.95	0.95	0.95	0.95	0.95
Adj. Flow (vph)	0	264	1	104	161	0	0	0	0	57	252	133
RTOR Reduction (vph)	0	0	0	0	0	0	0	0	0	0	64	0
Lane Group Flow (vph)	0	265	0	0	265	0	0	0	0	0	378	0
Confl. Peds. (#/hr)	9		8	8		9						
Confl. Bikes (#/hr)						3						
Turn Type		NA		Perm	NA					Perm	NA	
Protected Phases		8 6			8						7	
Permitted Phases				8						7		
Actuated Green, G (s)		40.8			17.4						13.1	
Effective Green, g (s)		40.8			17.4						13.1	
Actuated g/C Ratio		0.67			0.28						0.21	
Clearance Time (s)					3.6						3.6	
Vehicle Extension (s)					2.0						2.0	
Lane Grp Cap (vph)		1243			411						719	
v/s Ratio Prot		c0.14										
v/s Ratio Perm					c0.18						0.11	
v/c Ratio		0.21			0.64						0.53	
Uniform Delay, d1		3.9			19.1						21.2	
Progression Factor		0.19			1.00						1.00	
Incremental Delay, d2		0.0			2.6						0.3	
Delay (s)		0.8			21.7						21.6	
Level of Service		A			C						C	
Approach Delay (s)		0.8			21.7			0.0			21.6	
Approach LOS		A			C			A			C	
Intersection Summary												
HCM 2000 Control Delay			15.9			HCM 2000 Level of Service				B		
HCM 2000 Volume to Capacity ratio			0.45									
Actuated Cycle Length (s)			61.1			Sum of lost time (s)			10.8			
Intersection Capacity Utilization			49.8%			ICU Level of Service				A		
Analysis Period (min)			15									

c Critical Lane Group

Intersection

Intersection Delay, s/veh 12.4

Intersection LOS B

Movement	EBL	EBT	EBR	WBL	WBT	WBR	NBL	NBT	NBR	SBL	SBT	SBR
Lane Configurations		↔			↔			↔↔				
Traffic Vol, veh/h	137	168	0	0	247	85	5	135	93	0	0	0
Future Vol, veh/h	137	168	0	0	247	85	5	135	93	0	0	0
Peak Hour Factor	0.93	0.93	0.93	0.93	0.93	0.93	0.93	0.93	0.93	0.93	0.93	0.93
Heavy Vehicles, %	3	3	3	3	3	3	3	3	3	3	3	3
Mvmt Flow	147	181	0	0	266	91	5	145	100	0	0	0
Number of Lanes	0	1	0	0	1	0	0	2	0	0	0	0

Approach	EB	WB	NB
Opposing Approach	WB	EB	
Opposing Lanes	1	1	0
Conflicting Approach Left		NB	EB
Conflicting Lanes Left	0	2	1
Conflicting Approach Right	NB		WB
Conflicting Lanes Right	2	0	1
HCM Control Delay	13.1	12.9	10.6
HCM LOS	B	B	B

Lane	NBLn1	NBLn2	EBLn1	WBLn1
Vol Left, %	7%	0%	45%	0%
Vol Thru, %	93%	42%	55%	74%
Vol Right, %	0%	58%	0%	26%
Sign Control	Stop	Stop	Stop	Stop
Traffic Vol by Lane	73	161	305	332
LT Vol	5	0	137	0
Through Vol	68	68	168	247
RT Vol	0	93	0	85
Lane Flow Rate	78	173	328	357
Geometry Grp	7	7	2	2
Degree of Util (X)	0.137	0.281	0.48	0.497
Departure Headway (Hd)	6.307	5.86	5.27	5.008
Convergence, Y/N	Yes	Yes	Yes	Yes
Cap	569	613	685	721
Service Time	4.041	3.594	3.281	3.018
HCM Lane V/C Ratio	0.137	0.282	0.479	0.495
HCM Control Delay	10	10.9	13.1	12.9
HCM Lane LOS	A	B	B	B
HCM 95th-tile Q	0.5	1.1	2.6	2.8

Intersection

Intersection Delay, s/veh 9.3

Intersection LOS A

Movement	EBL	EBT	EBR	WBL	WBT	WBR	NBL	NBT	NBR	SBL	SBT	SBR
Lane Configurations		↔			↔			↔↔				
Traffic Vol, veh/h	76	37	0	0	33	3	24	322	11	0	0	0
Future Vol, veh/h	76	37	0	0	33	3	24	322	11	0	0	0
Peak Hour Factor	0.92	0.92	0.92	0.92	0.92	0.92	0.92	0.92	0.92	0.92	0.92	0.92
Heavy Vehicles, %	2	2	2	2	2	2	2	2	2	2	2	2
Mvmt Flow	83	40	0	0	36	3	26	350	12	0	0	0
Number of Lanes	0	1	0	0	1	0	0	2	0	0	0	0

Approach	EB	WB	NB
Opposing Approach	WB	EB	
Opposing Lanes	1	1	0
Conflicting Approach Left		NB	EB
Conflicting Lanes Left	0	2	1
Conflicting Approach Right	NB		WB
Conflicting Lanes Right	2	0	1
HCM Control Delay	9.1	8.2	9.5
HCM LOS	A	A	A

Lane	NBLn1	NBLn2	EBLn1	WBLn1
Vol Left, %	13%	0%	67%	0%
Vol Thru, %	87%	94%	33%	92%
Vol Right, %	0%	6%	0%	8%
Sign Control	Stop	Stop	Stop	Stop
Traffic Vol by Lane	185	172	113	36
LT Vol	24	0	76	0
Through Vol	161	161	37	33
RT Vol	0	11	0	3
Lane Flow Rate	201	187	123	39
Geometry Grp	7	7	2	2
Degree of Util (X)	0.28	0.254	0.171	0.054
Departure Headway (Hd)	5.008	4.898	5.004	4.934
Convergence, Y/N	Yes	Yes	Yes	Yes
Cap	718	735	717	726
Service Time	2.734	2.624	3.028	2.964
HCM Lane V/C Ratio	0.28	0.254	0.172	0.054
HCM Control Delay	9.7	9.3	9.1	8.2
HCM Lane LOS	A	A	A	A
HCM 95th-tile Q	1.1	1	0.6	0.2

Intersection

Intersection Delay, s/veh10.8

Intersection LOS B

Movement	EBL	EBT	EBR	WBL	WBT	WBR	NBL	NBT	NBR	SBL	SBT	SBR
Lane Configurations		↔			↔						↔↔	
Traffic Vol, veh/h	0	100	38	16	41	0	0	0	0	13	365	154
Future Vol, veh/h	0	100	38	16	41	0	0	0	0	13	365	154
Peak Hour Factor	0.91	0.91	0.91	0.91	0.91	0.91	0.91	0.91	0.91	0.91	0.91	0.91
Heavy Vehicles, %	2	2	2	2	2	2	2	2	2	2	2	2
Mvmt Flow	0	110	42	18	45	0	0	0	0	14	401	169
Number of Lanes	0	1	0	0	1	0	0	0	0	0	2	0

Approach	EB	WB	SB
Opposing Approach	WB	EB	
Opposing Lanes	1	1	0
Conflicting Approach Left	SB		WB
Conflicting Lanes Left	2	0	1
Conflicting Approach Right		SB	EB
Conflicting Lanes Right	0	2	1
HCM Control Delay	9.5	9.1	11.3
HCM LOS	A	A	B

Lane	EBLn1	WBLn1	SBLn1	SBLn2
Vol Left, %	0%	28%	7%	0%
Vol Thru, %	72%	72%	93%	54%
Vol Right, %	28%	0%	0%	46%
Sign Control	Stop	Stop	Stop	Stop
Traffic Vol by Lane	138	57	196	337
LT Vol	0	16	13	0
Through Vol	100	41	183	183
RT Vol	38	0	0	154
Lane Flow Rate	152	63	215	370
Geometry Grp	2	2	7	7
Degree of Util (X)	0.214	0.095	0.305	0.489
Departure Headway (Hd)	5.086	5.435	5.117	4.762
Convergence, Y/N	Yes	Yes	Yes	Yes
Cap	704	657	700	754
Service Time	3.13	3.488	2.86	2.505
HCM Lane V/C Ratio	0.216	0.096	0.307	0.491
HCM Control Delay	9.5	9.1	10.1	12
HCM Lane LOS	A	A	B	B
HCM 95th-tile Q	0.8	0.3	1.3	2.7

1: S Auburn St & EB Off Ramp/Hansen Way Performance by movement

Movement	EBL	EBT	EBR	NBT	NBR	SBL	SBT	All
Denied Delay (hr)	53.8	24.6	22.5	4.9	3.7	0.0	0.0	109.4
Denied Del/Veh (s)	993.0	932.5	940.6	73.7	79.1	0.0	0.0	357.1
Total Delay (hr)	38.5	20.0	15.3	15.1	10.6	0.0	0.1	99.6
Total Del/Veh (s)	1506.4	1599.8	1372.9	233.5	229.7	4.2	1.2	399.2
Vehicles Entered	67	35	31	228	160	14	307	842
Vehicles Exited	52	25	23	212	151	14	307	784
Hourly Exit Rate	52	25	23	212	151	14	307	784
Input Volume	204	96	85	220	170	14	294	1084
% of Volume	25	26	27	96	89	98	104	72

2: S Auburn St & WB On Ramp/Tinloy St Performance by movement

Movement	WBL	WBT	NBL	NBT	SBT	SBR	All
Denied Delay (hr)	0.0	0.0	0.0	0.3	0.0	0.0	0.3
Denied Del/Veh (s)	0.0	0.0	2.1	3.8	0.1	0.1	0.9
Total Delay (hr)	0.5	2.3	0.3	3.5	0.3	0.2	7.2
Total Del/Veh (s)	25.3	29.0	56.5	49.3	4.5	2.9	22.6
Vehicles Entered	72	280	21	251	254	252	1130
Vehicles Exited	72	280	21	252	253	252	1130
Hourly Exit Rate	72	280	21	252	253	252	1130
Input Volume	74	274	34	397	238	248	1265
% of Volume	97	102	62	64	106	102	89















3: S Auburn St & Neal St Performance by movement

Movement	EBL	EBT	EBR	WBT	WBR	NBL	NBT	SBL	SBT	SBR	All
Denied Delay (hr)	0.0	0.0	0.0	0.0	0.0	0.1	0.0	0.0	0.0	0.0	0.2
Denied Del/Veh (s)	1.6	0.4	0.4	0.0	0.0	1.4	0.0	2.4	0.4	0.4	0.5
Total Delay (hr)	0.6	2.2	2.1	0.5	0.1	1.7	0.1	0.2	2.0	0.5	10.0
Total Del/Veh (s)	44.2	40.2	32.6	8.5	3.0	41.9	4.0	20.6	26.6	20.1	24.4
Vehicles Entered	51	193	224	197	145	141	115	32	271	91	1460
Vehicles Exited	52	193	225	197	145	141	115	32	273	89	1462
Hourly Exit Rate	52	193	225	197	145	141	115	32	273	89	1462
Input Volume	55	201	219	194	148	212	184	34	259	87	1593
% of Volume	95	96	103	102	98	66	62	93	106	102	92

HCM Signalized Intersection Capacity Analysis
2: S Auburn St & WB On Ramp/Tinloy St

Year 2045 Conditions - No Build





















Vissim Volumes

												
Movement	EBL	EBT	EBR	WBL	WBT	WBR	NBL	NBT	NBR	SBL	SBT	SBR
Lane Configurations												
Traffic Volume (vph)	0	0	0	74	270	0	34	390	0	0	230	248
Future Volume (vph)	0	0	0	74	270	0	34	390	0	0	230	248
Ideal Flow (vphpl)	1900	1900	1900	1900	1900	1900	1900	1900	1900	1900	1900	1900
Total Lost time (s)					3.6			3.6			3.6	
Lane Util. Factor					0.95			0.95			1.00	
Frbp, ped/bikes					1.00			1.00			0.97	
Flpb, ped/bikes					1.00			1.00			1.00	
Frt					1.00			1.00			0.93	
Flt Protected					0.99			1.00			1.00	
Satd. Flow (prot)					3502			3525			1688	
Flt Permitted					0.99			0.63			1.00	
Satd. Flow (perm)					3502			2240			1688	
Peak-hour factor, PHF	0.91	0.91	0.91	0.91	0.91	0.91	0.91	0.91	0.91	0.91	0.91	0.91
Adj. Flow (vph)	0	0	0	81	297	0	37	429	0	0	253	273
RTOR Reduction (vph)	0	0	0	0	0	0	0	0	0	0	51	0
Lane Group Flow (vph)	0	0	0	0	378	0	0	466	0	0	475	0
Confl. Peds. (#/hr)							17		10	10		17
Turn Type				Perm	NA		Perm	NA			NA	
Protected Phases					7			2 6			6 8	
Permitted Phases				7			2 6					
Actuated Green, G (s)					14.2			25.0			48.2	
Effective Green, g (s)					14.2			25.0			48.2	
Actuated g/C Ratio					0.20			0.36			0.69	
Clearance Time (s)					3.6							
Vehicle Extension (s)					2.0							
Lane Grp Cap (vph)					714			804			1168	
v/s Ratio Prot											c0.28	
v/s Ratio Perm					0.11			c0.21				
v/c Ratio					0.53			0.58			0.41	
Uniform Delay, d1					24.7			18.0			4.6	
Progression Factor					0.70			1.00			0.05	
Incremental Delay, d2					0.3			0.6			0.1	
Delay (s)					17.6			18.7			0.3	
Level of Service					B			B			A	
Approach Delay (s)		0.0			17.6			18.7			0.3	
Approach LOS		A			B			B			A	
Intersection Summary												
HCM 2000 Control Delay			11.3		HCM 2000 Level of Service						B	
HCM 2000 Volume to Capacity ratio			0.52									
Actuated Cycle Length (s)			69.6		Sum of lost time (s)						10.8	
Intersection Capacity Utilization			53.2%		ICU Level of Service						A	
Analysis Period (min)			15									
c Critical Lane Group												

HCM Signalized Intersection Capacity Analysis
3: S Auburn St & Neal St

Year 2045 Conditions - No Build

Vissim Volumes

													
Movement	EBL	EBT	EBR	WBL	WBT	WBR	NBL	NBT	NBR	SBL	SBT	SBR	
Lane Configurations													
Traffic Volume (vph)	55	201	219	0	192	148	212	178	0	34	259	87	
Future Volume (vph)	55	201	219	0	192	148	212	178	0	34	259	87	
Ideal Flow (vphpl)	1900	1900	1900	1900	1900	1900	1900	1900	1900	1900	1900	1900	
Total Lost time (s)	3.6	3.6			3.6	3.6	3.6	3.6		3.6	3.6		
Lane Util. Factor	1.00	1.00			1.00	1.00	1.00	1.00		1.00	1.00		
Frbp, ped/bikes	1.00	0.98			1.00	0.96	1.00	1.00		1.00	0.99		
Flpb, ped/bikes	0.99	1.00			1.00	1.00	0.99	1.00		0.99	1.00		
Frt	1.00	0.92			1.00	0.85	1.00	1.00		1.00	0.96		
Flt Protected	0.95	1.00			1.00	1.00	0.95	1.00		0.95	1.00		
Satd. Flow (prot)	1746	1680			1863	1523	1748	1863		1754	1772		
Flt Permitted	0.63	1.00			1.00	1.00	0.38	1.00		0.60	1.00		
Satd. Flow (perm)	1164	1680			1863	1523	708	1863		1114	1772		
Peak-hour factor, PHF	0.97	0.97	0.97	0.97	0.97	0.97	0.97	0.97	0.97	0.97	0.97	0.97	
Adj. Flow (vph)	57	207	226	0	198	153	219	184	0	35	267	90	
RTOR Reduction (vph)	0	52	0	0	0	71	0	0	0	0	16	0	
Lane Group Flow (vph)	57	381	0	0	198	82	219	184	0	35	341	0	
Confl. Peds. (#/hr)	9		11	11		9	14		7	7		14	
Confl. Bikes (#/hr)						2							
Turn Type	Perm	NA			NA	Perm	Perm	NA		Perm	NA		
Protected Phases		8			8			2			6		
Permitted Phases	8					8	2			6			
Actuated Green, G (s)	19.6	19.6			37.4	37.4	25.0	25.0		25.0	25.0		
Effective Green, g (s)	19.6	19.6			37.4	37.4	25.0	25.0		25.0	25.0		
Actuated g/C Ratio	0.28	0.28			0.54	0.54	0.36	0.36		0.36	0.36		
Clearance Time (s)	3.6	3.6								3.6	3.6		
Vehicle Extension (s)	2.0	2.0								2.0	2.0		
Lane Grp Cap (vph)	327	473			1001	818	254	669		400	636		
v/s Ratio Prot		c0.23			c0.11			0.10				0.19	
v/s Ratio Perm	0.05					0.05	c0.31			0.03			
v/c Ratio	0.17	0.80			0.20	0.10	0.86	0.28		0.09	0.54		
Uniform Delay, d1	18.9	23.2			8.3	7.9	20.7	15.9		14.8	17.7		
Progression Factor	1.00	1.00			0.33	0.20	0.34	0.14		1.00	1.00		
Incremental Delay, d2	0.1	9.1			0.0	0.0	20.9	0.1		0.0	0.4		
Delay (s)	19.0	32.3			2.8	1.6	27.9	2.3		14.8	18.1		
Level of Service	B	C			A	A	C	A		B	B		
Approach Delay (s)		30.8			2.3			16.2			17.8		
Approach LOS		C			A			B			B		
Intersection Summary													
HCM 2000 Control Delay			18.0		HCM 2000 Level of Service						B		
HCM 2000 Volume to Capacity ratio			0.69										
Actuated Cycle Length (s)			69.6		Sum of lost time (s)						10.8		
Intersection Capacity Utilization			65.6%		ICU Level of Service						C		
Analysis Period (min)			15										

















c Critical Lane Group

HCM Signalized Intersection Capacity Analysis

Year 2045 Conditions - No Build

4: Tinloy St & Neal St

Vissim Volumes

													
Movement	EBL	EBT	EBR	WBL	WBT	WBR	NBL	NBT	NBR	SBL	SBT	SBR	
Lane Configurations													
Traffic Volume (vph)	0	235	0	90	195	0	0	0	0	86	254	145	
Future Volume (vph)	0	235	0	90	195	0	0	0	0	86	254	145	
Ideal Flow (vphpl)	1900	1900	1900	1900	1900	1900	1900	1900	1900	1900	1900	1900	
Total Lost time (s)		3.6			3.6						3.6		
Lane Util. Factor		1.00			1.00						0.95		
Frbp, ped/bikes		1.00			1.00						1.00		
Flpb, ped/bikes		1.00			1.00						1.00		
Frt		1.00			1.00						0.96		
Flt Protected		1.00			0.98						0.99		
Satd. Flow (prot)		1863			1830						3350		
Flt Permitted		1.00			0.82						0.99		
Satd. Flow (perm)		1863			1527						3350		
Peak-hour factor, PHF	0.95	0.95	0.95	0.95	0.95	0.95	0.95	0.95	0.95	0.95	0.95	0.95	
Adj. Flow (vph)	0	247	0	95	205	0	0	0	0	91	267	153	
RTOR Reduction (vph)	0	0	0	0	0	0	0	0	0	0	64	0	
Lane Group Flow (vph)	0	247	0	0	300	0	0	0	0	0	447	0	
Confl. Peds. (#/hr)	9		8	8			9						
Confl. Bikes (#/hr)						3							
Turn Type		NA		Perm	NA					Perm	NA		
Protected Phases		8 6			8						7		
Permitted Phases				8						7			
Actuated Green, G (s)		48.2			19.6						14.2		
Effective Green, g (s)		48.2			19.6						14.2		
Actuated g/C Ratio		0.69			0.28						0.20		
Clearance Time (s)					3.6						3.6		
Vehicle Extension (s)					2.0						2.0		
Lane Grp Cap (vph)		1290			430						683		
v/s Ratio Prot		c0.13											
v/s Ratio Perm					c0.20						0.13		
v/c Ratio		0.19			0.70						0.65		
Uniform Delay, d1		3.8			22.4						25.4		
Progression Factor		0.19			1.00						1.00		
Incremental Delay, d2		0.0			4.0						1.7		
Delay (s)		0.7			26.3						27.2		
Level of Service		A			C						C		
Approach Delay (s)		0.7			26.3			0.0			27.2		
Approach LOS		A			C			A			C		
Intersection Summary													
HCM 2000 Control Delay			20.8									HCM 2000 Level of Service	C
HCM 2000 Volume to Capacity ratio			0.48										
Actuated Cycle Length (s)			69.6									Sum of lost time (s)	10.8
Intersection Capacity Utilization			52.4%									ICU Level of Service	A
Analysis Period (min)			15										

c Critical Lane Group

Intersection												
Intersection Delay, s/veh	14.1											
Intersection LOS	B											

Movement	EBL	EBT	EBR	WBL	WBT	WBR	NBL	NBT	NBR	SBL	SBT	SBR
Lane Configurations		↔			↔			↔↔				
Traffic Vol, veh/h	137	184	0	0	285	100	0	170	110	0	0	0
Future Vol, veh/h	137	184	0	0	285	100	0	170	110	0	0	0
Peak Hour Factor	0.93	0.93	0.93	0.93	0.93	0.93	0.93	0.93	0.93	0.93	0.93	0.93
Heavy Vehicles, %	3	3	3	3	3	3	3	3	3	3	3	3
Mvmt Flow	147	198	0	0	306	108	0	183	118	0	0	0
Number of Lanes	0	1	0	0	1	0	0	2	0	0	0	0

Approach	EB	WB	NB
Opposing Approach	WB	EB	
Opposing Lanes	1	1	0
Conflicting Approach Left		NB	EB
Conflicting Lanes Left	0	2	1
Conflicting Approach Right	NB		WB
Conflicting Lanes Right	2	0	1
HCM Control Delay	14.6	15.7	11.3
HCM LOS	B	C	B

Lane	NBLn1	NBLn2	EBLn1	WBLn1
Vol Left, %	0%	0%	43%	0%
Vol Thru, %	100%	34%	57%	74%
Vol Right, %	0%	66%	0%	26%
Sign Control	Stop	Stop	Stop	Stop
Traffic Vol by Lane	113	167	321	385
LT Vol	0	0	137	0
Through Vol	113	57	184	285
RT Vol	0	110	0	100
Lane Flow Rate	122	179	345	414
Geometry Grp	7	7	2	2
Degree of Util (X)	0.22	0.3	0.528	0.597
Departure Headway (Hd)	6.501	6.031	5.505	5.19
Convergence, Y/N	Yes	Yes	Yes	Yes
Cap	552	595	656	695
Service Time	4.244	3.774	3.543	3.226
HCM Lane V/C Ratio	0.221	0.301	0.526	0.596
HCM Control Delay	11.1	11.4	14.6	15.7
HCM Lane LOS	B	B	B	C
HCM 95th-tile Q	0.8	1.3	3.1	4

Check raw data to ensure that the results are lining up with the colored rows.

Average	VehDelay (All)	LOS	RNDBT
1	48.9	E	TWSC
2	2.2	A	RNDBT
4	3.4	A	RNDBT
5	9.1	A	Signal
6	17.5	B	RNDBT
7	3.2	A	RNDBT
8	16.4	C	TWSC
RNDBT	6.4	A	RNDBT

Volume	Link	Movement	
234	1: SR 49 NB Off Ramp - 1@310.2 - 3@245.5	EBL	
29	1: SR 49 NB Off Ramp - 2@40.5 - 6@641.4	EBR	
377	1: SR 49 NB Off Ramp - 3@119.8 - 3@245.5	NBT	
355	1: SR 49 NB Off Ramp - 6@510.4 - 6@641.4	SBT	
3	1: SR 49 NB Off Ramp - 15@30.8 - 3@245.5	WBL	School Dwy
998	1: SR 49 NB Off Ramp		
631	2: NB Roundabout entry - 3@266.7 - 3@328.5	NBR	
355	2: NB Roundabout entry - 6@425.7 - 6@489.2	SBT	
986	2: NB Roundabout entry		
330	4: SR 49 SB On Ramp - 4@375.6 - 4@557.5	WBT	
196	4: SR 49 SB On Ramp - 4@375.6 - 6@355.4	WBL	
146	4: SR 49 SB On Ramp - 5@7.7 - 5@147.0	SBR to Fwy from Auburn St	
526	4: SR 49 SB On Ramp - 6@232.0 - 6@355.4	SBT	
115	4: SR 49 SB On Ramp - 10005@49.9 - 5@147.0	SBR to Fwy from Neal St	
1312	4: SR 49 SB On Ramp		
181	5: Neal St/Auburn St - 6@83.4 - 6@217.8	SBT	
52	5: Neal St/Auburn St - 6@83.4 - 13@50.4	SBR	
145	5: Neal St/Auburn St - 6@83.4 - 10009@64.4	SBT to Fwy	
395	5: Neal St/Auburn St - 7@771.9 - 13@50.4	WBT	
340	5: Neal St/Auburn St - 8@26.2 - 9@40.3	WBR	
344	5: Neal St/Auburn St - 10@179.0 - 10017@57.9	EBR to SBT	
115	5: Neal St/Auburn St - 10004@32.2 - 10005@33.4	EBR to Fwy	
1572	5: Neal St/Auburn St		
381	6: Neal St/Tinloy St - 4@179.3 - 4@264.9	SBT	
89	6: Neal St/Tinloy St - 4@179.3 - 10019@17.6	SBR	
646	6: Neal St/Tinloy St - 7@582.3 - 7@654.2	WBT	
142	6: Neal St/Tinloy St - 7@582.3 - 10014@11.1	WBL	
1258	6: Neal St/Tinloy St		
260	7: Neal St/SR 174 - 3@597.2 - 3@661.9	EBT	
247	7: Neal St/SR 174 - 3@597.2 - 10013@14.7	EBT to EBL	
299	7: Neal St/SR 174 - 7@488.3 - 7@557.8	WBT	
489	7: Neal St/SR 174 - 10018@39.7 - 10018@85.1	EBL	
1296	7: Neal St/SR 174		
260	8: Neal St/Hansen Way - 3@709.3 - 3@819.2	EBT	
299	8: Neal St/Hansen Way - 7@315.2 - 7@424.9	WBT	
99	8: Neal St/Hansen Way - 7@315.2 - 12@30.8	WBR	
247	8: Neal St/Hansen Way - 14@28.0 - 12@30.8	EBL	
906	8: Neal St/Hansen Way		

APPENDIX B

Intersection Improvement Concept - Alternative 5



INDEX OF SHEETS

- FIGURE 1: TITLE SHEET
- FIGURE 2-5: FAST PATHS
- FIGURE 6-11: TRUCK TURNS
- FIGURE 12-17: BUS TURNS

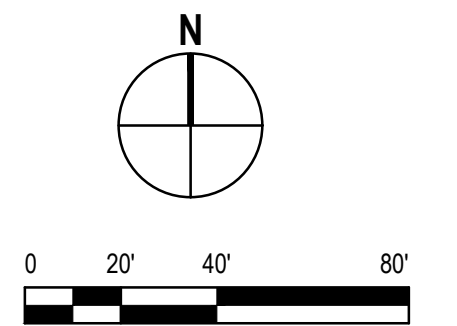
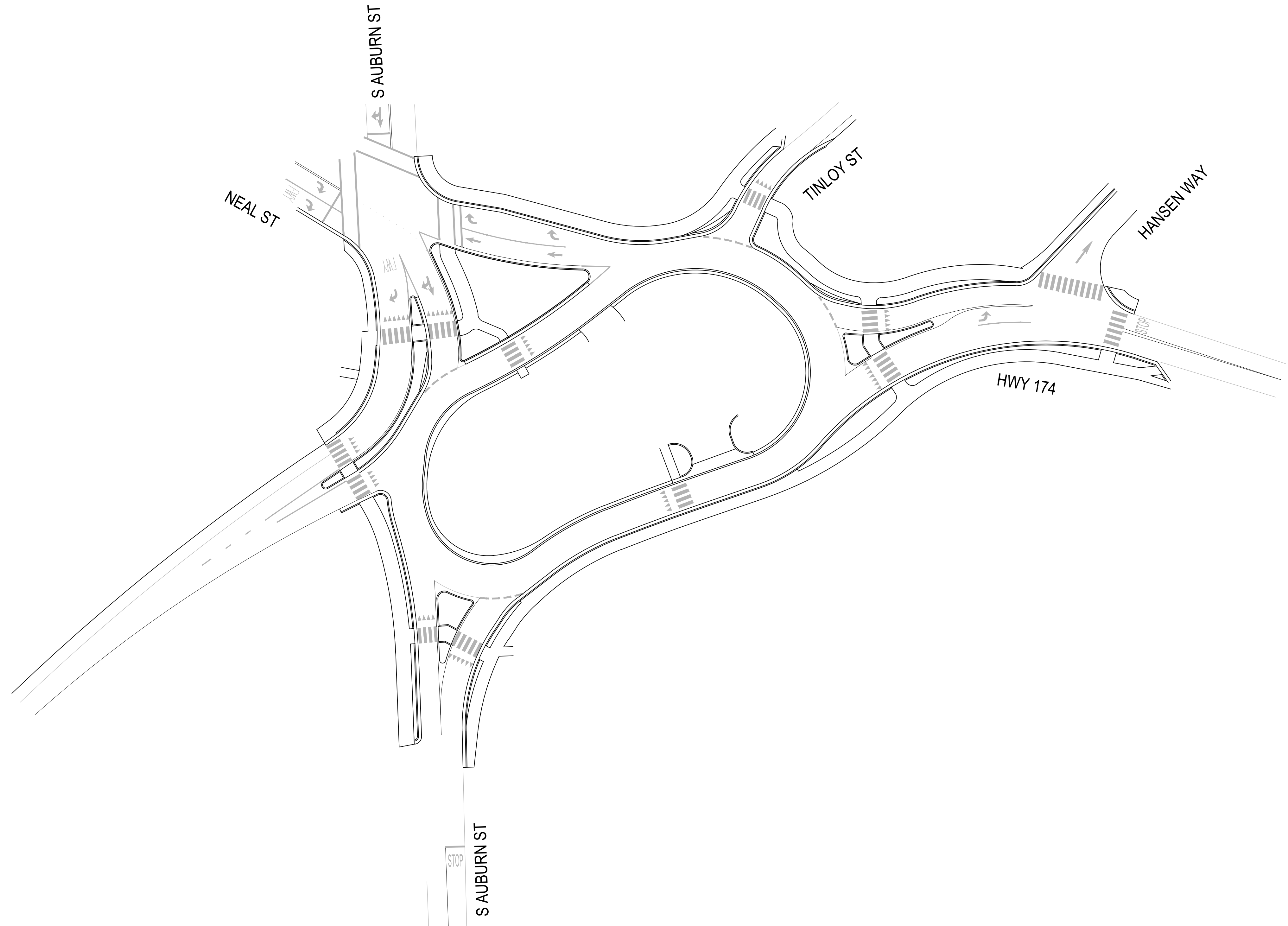

PRELIMINARY
SUBJECT TO CHANGE

GRASS VALLEY ROUNDABOUTS PROJECT

TITLE SHEET







943 Reserve Drive, Suite 100
Roseville, CA 95678 USA
T 1 916 782 8688 W www.ghd.com

Project No. 2162
Date DEC 2019

FIGURE 01

LEGEND:

-  FAST PATH
-  FAST PATH IDENTIFIER
-  MOVEMENT DESIGNATION
-  STREET NAME ABBREVIATION
-  DIRECTION

Movement	Southbound Neal St (S#)
Entering (V1)	21.5
Circulating (V2)	20.3
Exiting (V3)	37.7
Left Turn (V4)	16.0
Right Turn (V5)	21.3

Notes:
 All values are in miles per hour
 V3 exiting speeds are derived from vehicle acceleration formulas in NCHRP 672
 V3 fast path speed measured at exit crosswalk or 100 feet downstream from V2.
 N/A = Fastest path speed does not exist for this approach
 2% cross-slope assumed for determining Fastest path

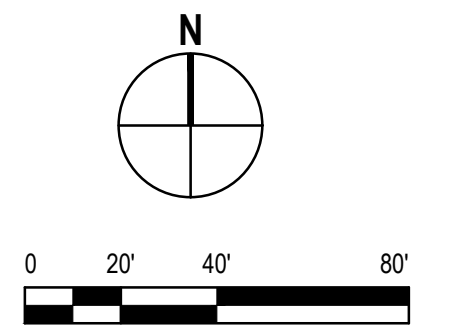
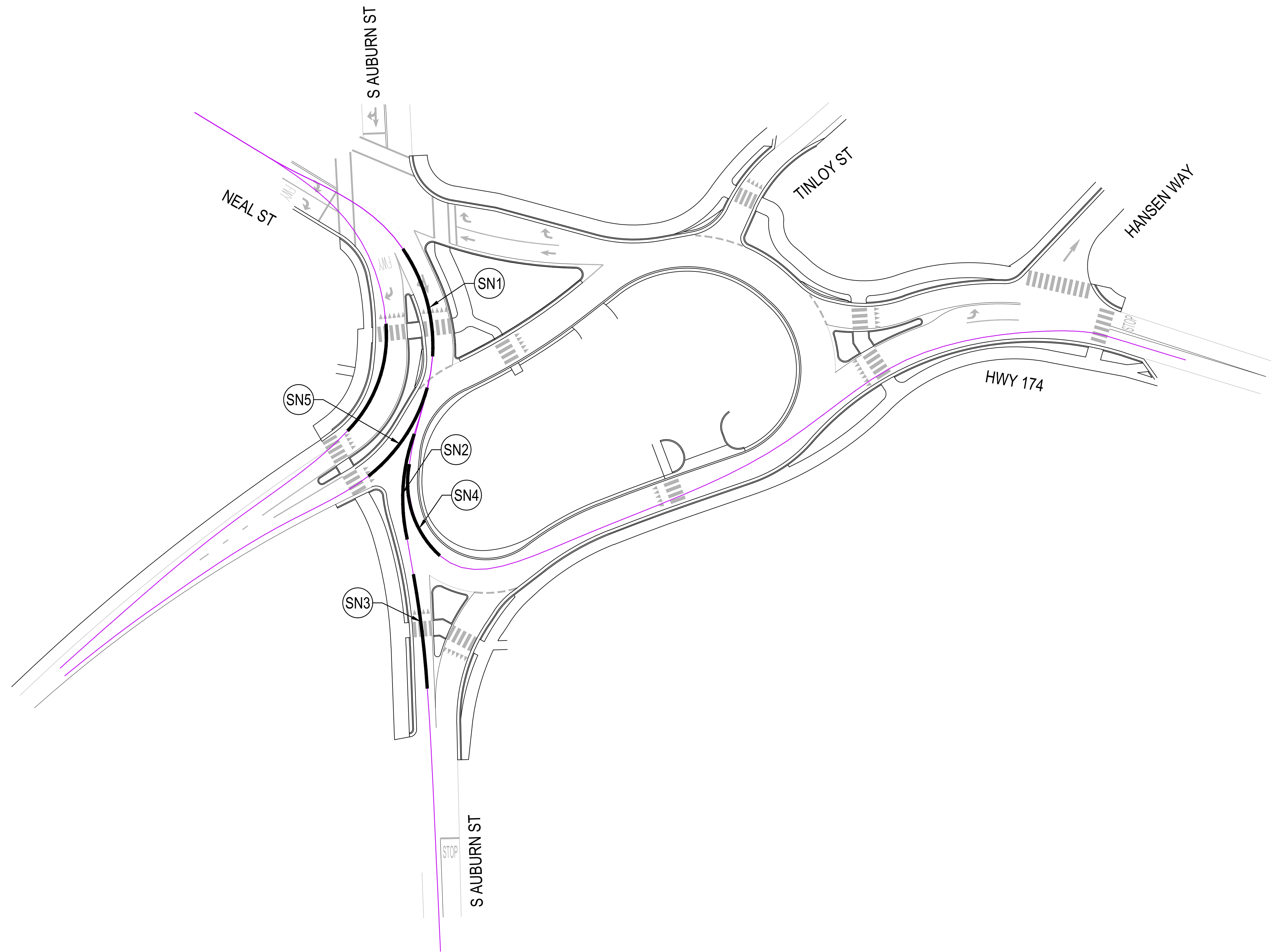

PRELIMINARY
 SUBJECT TO CHANGE

GRASS VALLEY ROUNDABOUTS PROJECT

FAST PATH - SOUTHBOUND NEAL ST







943 Reserve Drive, Suite 100
 Roseville, CA 95678 USA
 T 1 916 782 8688 W www.ghd.com

Project No. 2162
 Date DEC 2019

FIGURE 02

LEGEND:

-  FAST PATH
-  FAST PATH IDENTIFIER
-  MOVEMENT DESIGNATION
-  STREET NAME ABBREVIATION
-  DIRECTION

Movement	Northbound S Auburn St (#)
Entering (V1)	22.8
Circulating (V2)	18.7
Exiting (V3)	25.4
Left Turn (V4)	17.7
Right Turn (V5)	21.9

Notes:
 All values are in miles per hour
 V3 exiting speeds are derived from vehicle acceleration formulas in NCHRP 672
 V3 fast path speed measured at exit crosswalk or 100 feet downstream from V2.
 N/A = Fastest path speed does not exist for this approach
 2% cross-slope assumed for determining Fastest path

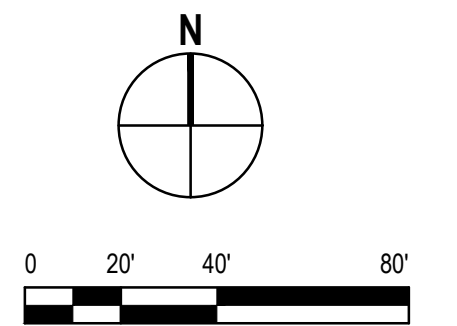
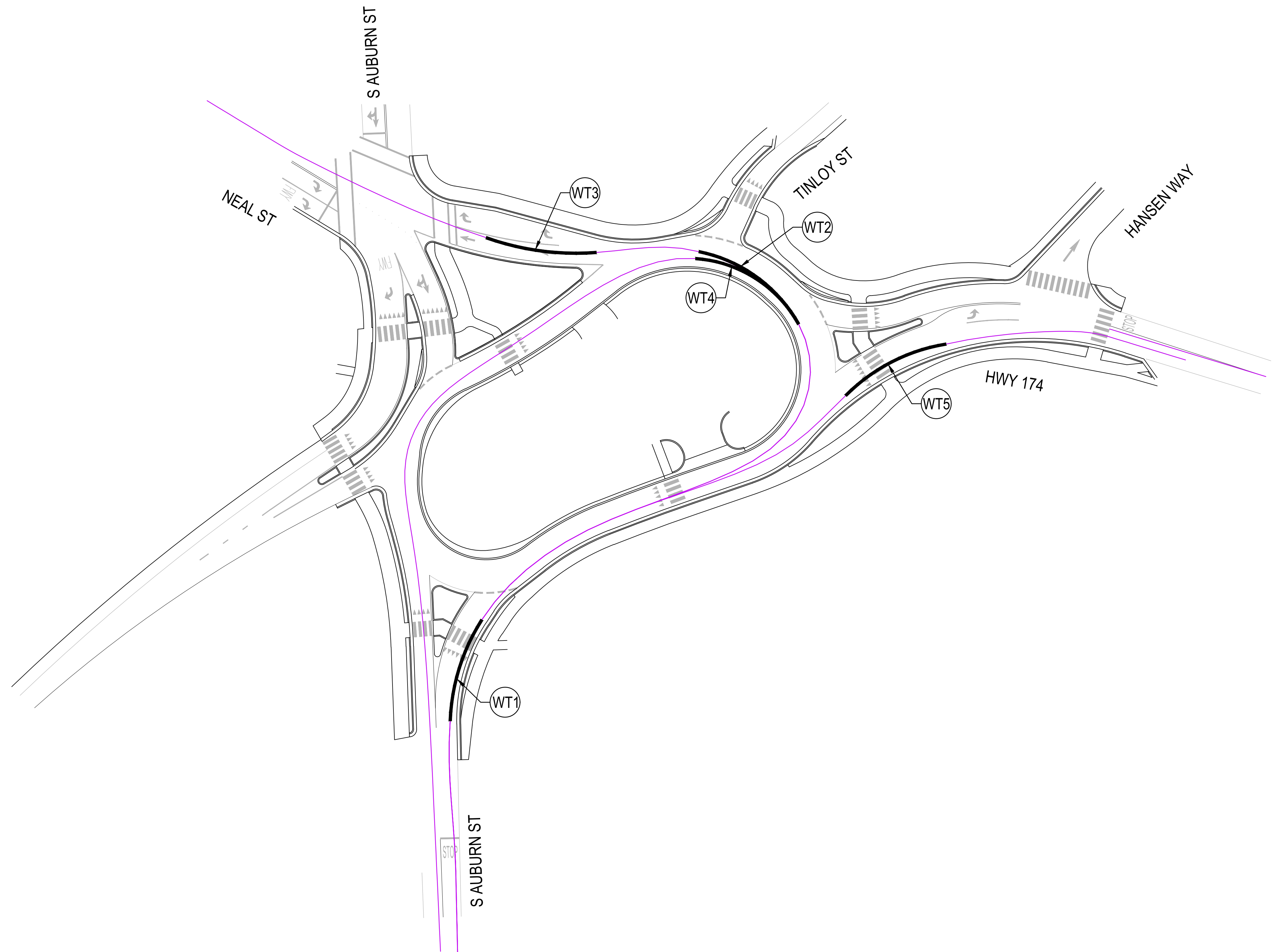

PRELIMINARY
 SUBJECT TO CHANGE

GRASS VALLEY ROUNDABOUTS PROJECT

FAST PATH - NORTHBOUND S AUBURN ST







943 Reserve Drive, Suite 100
 Roseville, CA 95678 USA
 T 916 782 8688 W www.ghd.com

Project No. 2162
 Date DEC 2019

FIGURE 03

LEGEND:

-  FAST PATH
-  FAST PATH IDENTIFIER
-  MOVEMENT DESIGNATION
-  STREET NAME ABBREVIATION
-  DIRECTION

Movement	Westbound Highway 174 (W#)
Entering (V1)	22.7
Circulating (V2)	21.4
Exiting (V3)	33.1
Left Turn (V4)	14.5
Right Turn (V5)	N/A

Notes:
 All values are in miles per hour
 V3 exiting speeds are derived from vehicle acceleration formulas in NCHRP 672
 V3 fast path speed measured at exit crosswalk or 100 feet downstream from V2.
 N/A = Fastest path speed does not exist for this approach
 2% cross-slope assumed for determining Fastest path

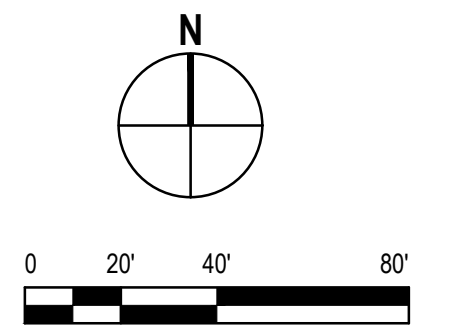
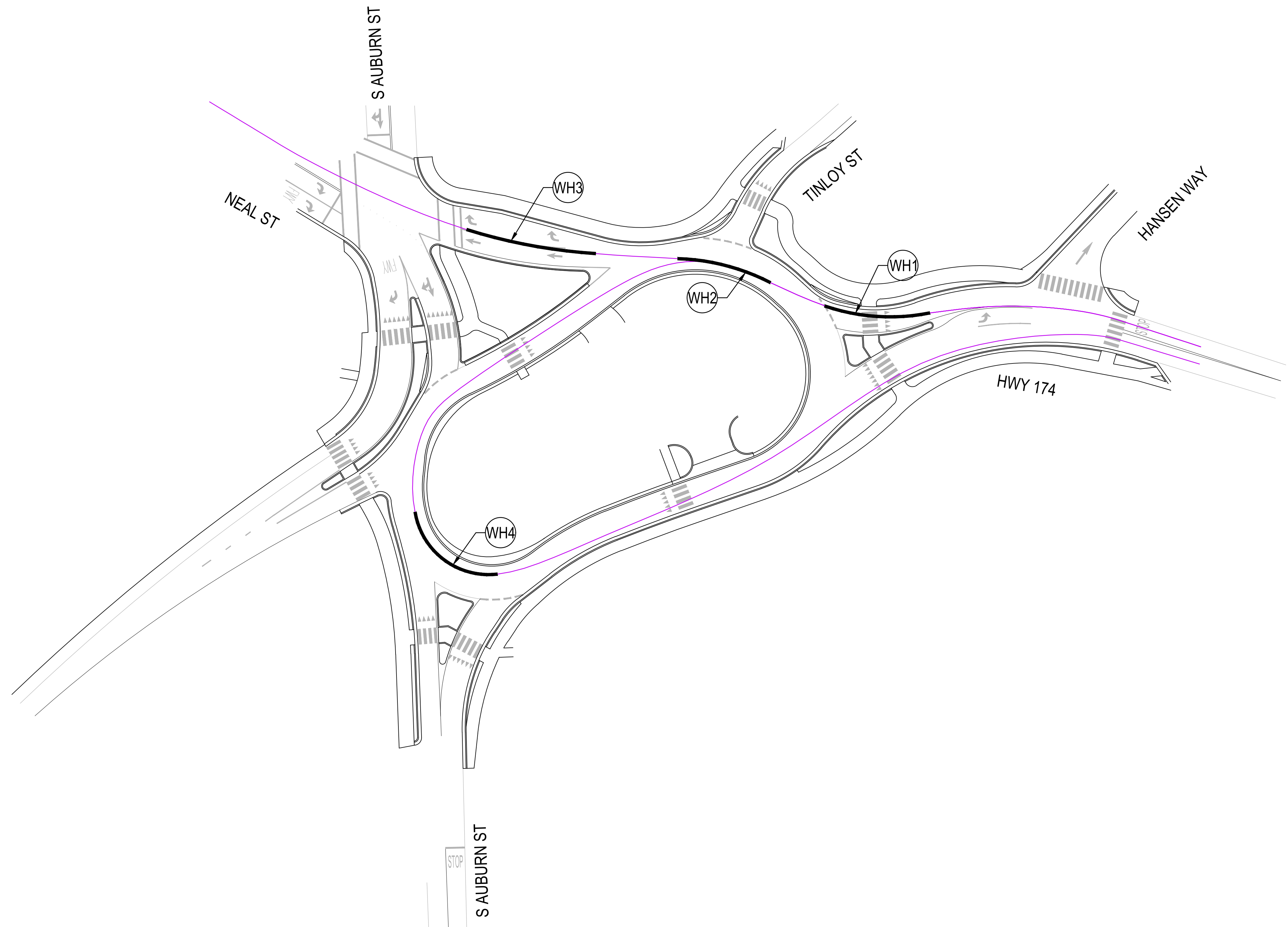

PRELIMINARY
 SUBJECT TO CHANGE

GRASS VALLEY ROUNDABOUTS PROJECT

FAST PATH - WESTBOUND HIGHWAY 174







943 Reserve Drive, Suite 100
 Roseville, CA 95678 USA
 T 1 916 782 8688 W www.ghd.com

Project No. 2162
 Date DEC 2019

FIGURE 04

LEGEND:

-  FAST PATH
-  FAST PATH IDENTIFIER
-  MOVEMENT DESIGNATION
-  STREET NAME ABBREVIATION
-  DIRECTION

Movement	Westbound Tinloy St (V#)
Entering (V1)	19.9
Circulating (V2)	22.2
Exiting (V3)	33.6
Left Turn (V4)	16.5
Right Turn (V5)	19.0

Notes:
 All values are in miles per hour
 V3 exiting speeds are derived from vehicle acceleration formulas in NCHRP 672
 V3 fast path speed measured at exit crosswalk or 100 feet downstream from V2.
 N/A = Fastest path speed does not exist for this approach
 2% cross-slope assumed for determining Fastest path

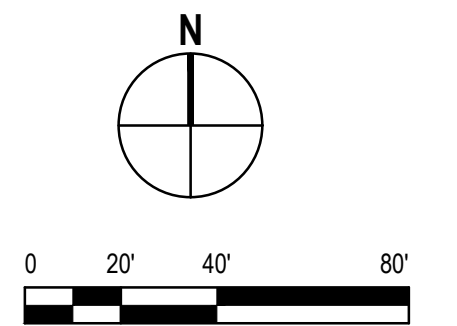
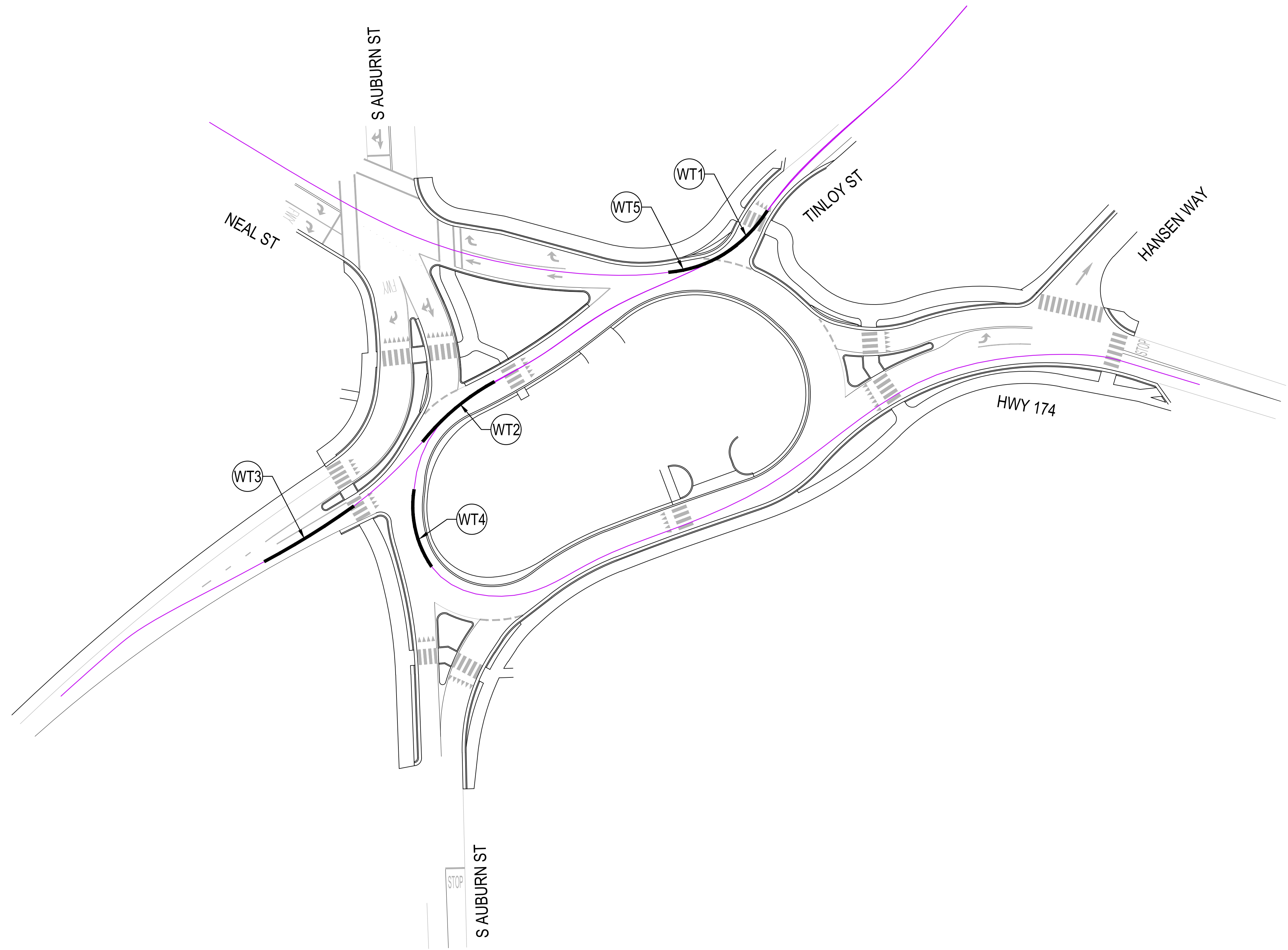

PRELIMINARY
 SUBJECT TO CHANGE

GRASS VALLEY ROUNDABOUTS PROJECT

FAST PATH - WESTBOUND HIGHWAY 174



943 Reserve Drive, Suite 100
 Roseville, CA 95678 USA
 T 916 782 8688 W www.ghd.com

Project No. 2162
 Date DEC 2019

FIGURE 05

VEHICLE PROFILE

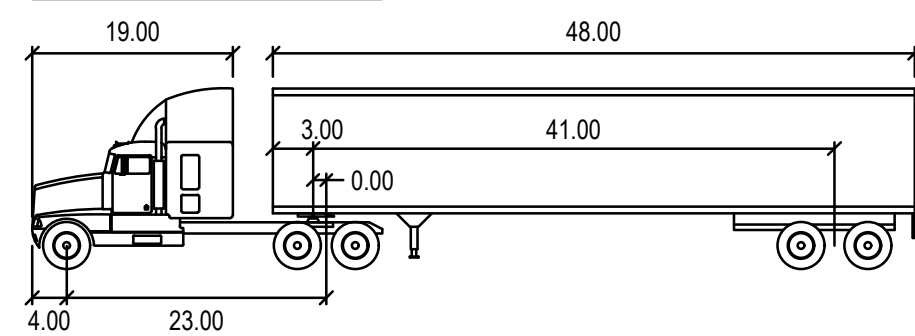

STAA - STANDARD	feet		
Tractor Width	: 8.50	Lock to Lock Time	: 6.0
Trailer Width	: 8.50	Steering Angle	: 26.3
Tractor Track	: 8.50	Articulating Angle	: 70.0
Trailer Track	: 8.50		

LEGEND

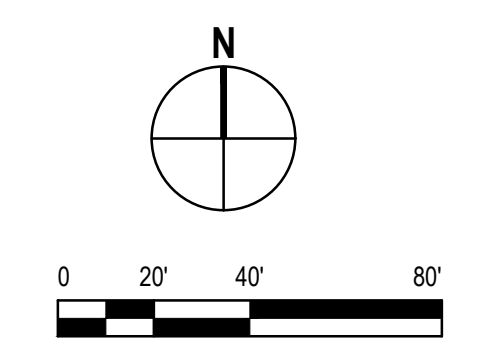
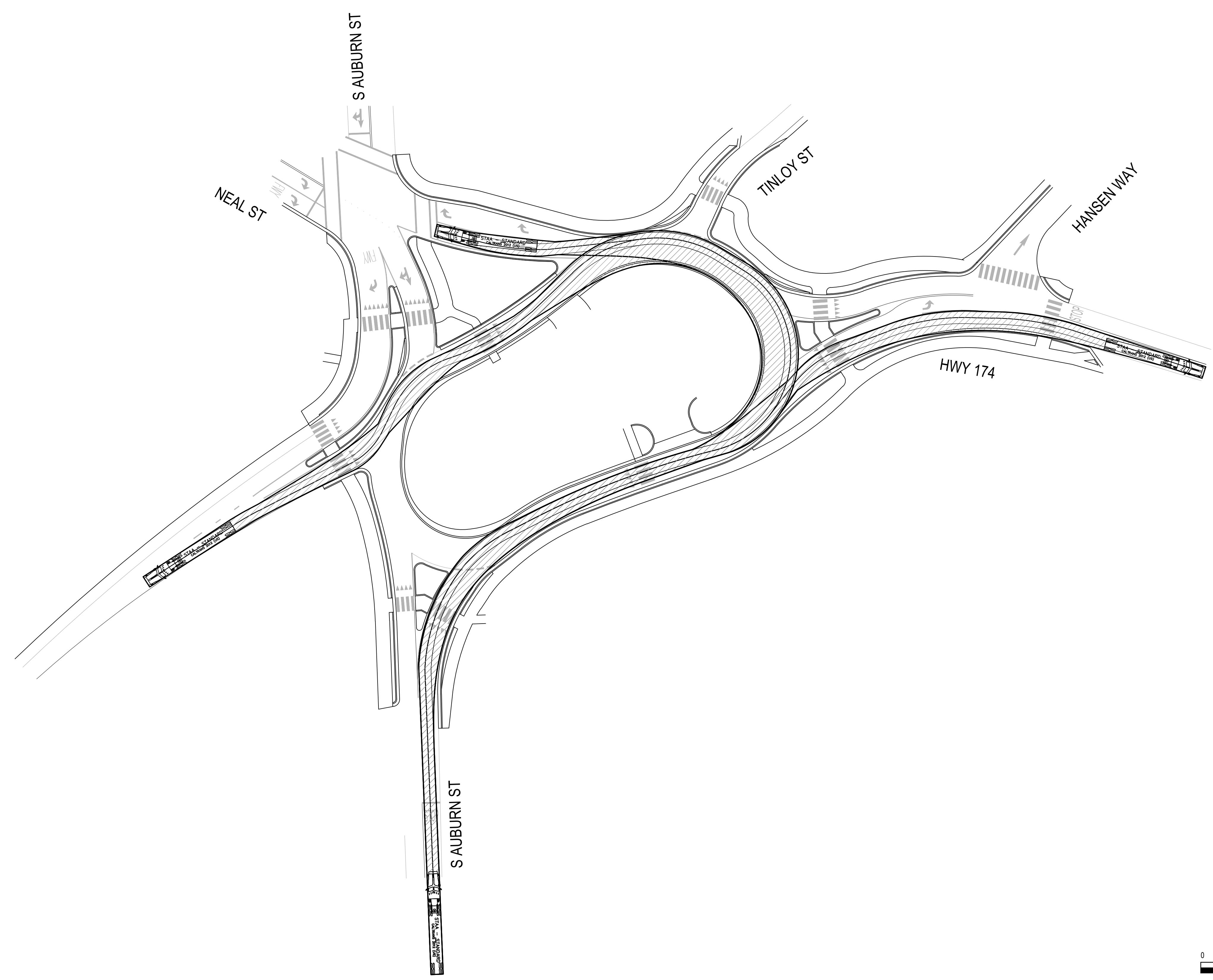
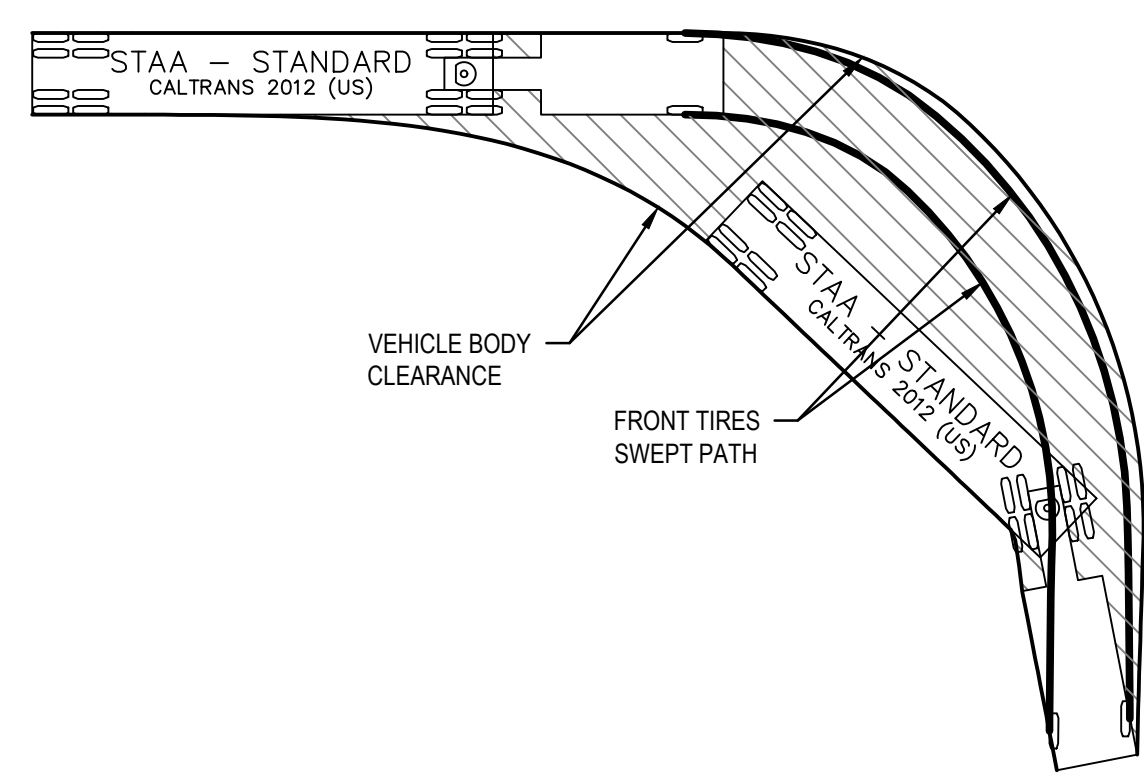

PRELIMINARY
SUBJECT TO CHANGE

GRASS VALLEY ROUNDABOUTS PROJECT
TRUCK TURNS - NORTHBOUND S AUBURN ST



Project No. 2162
Date DEC 2019

FIGURE 06

Filename: N:\US\Roseville\Projects\Legacy\PRJ2612\2612EX004.dwg
Plot Date: 8 April 2020 - 1:47 PM

VEHICLE PROFILE

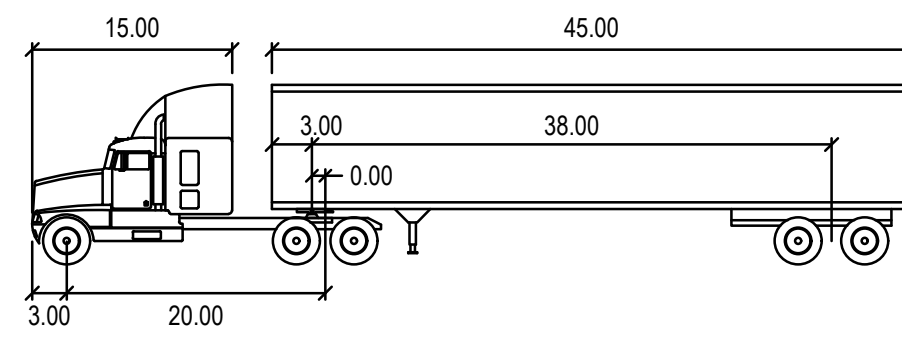

CA LEGAL - 65 FT (60 FT RADIUS)
feet

Tractor Width	: 8.50	Lock to Lock Time	: 6.0
Trailer Width	: 8.50	Steering Angle	: 26.3
Tractor Track	: 8.50	Articulating Angle	: 70.0
Trailer Track	: 8.50		

LEGEND

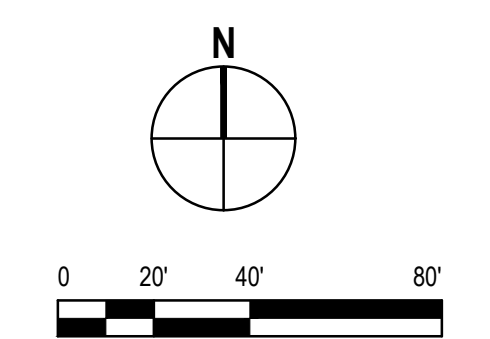
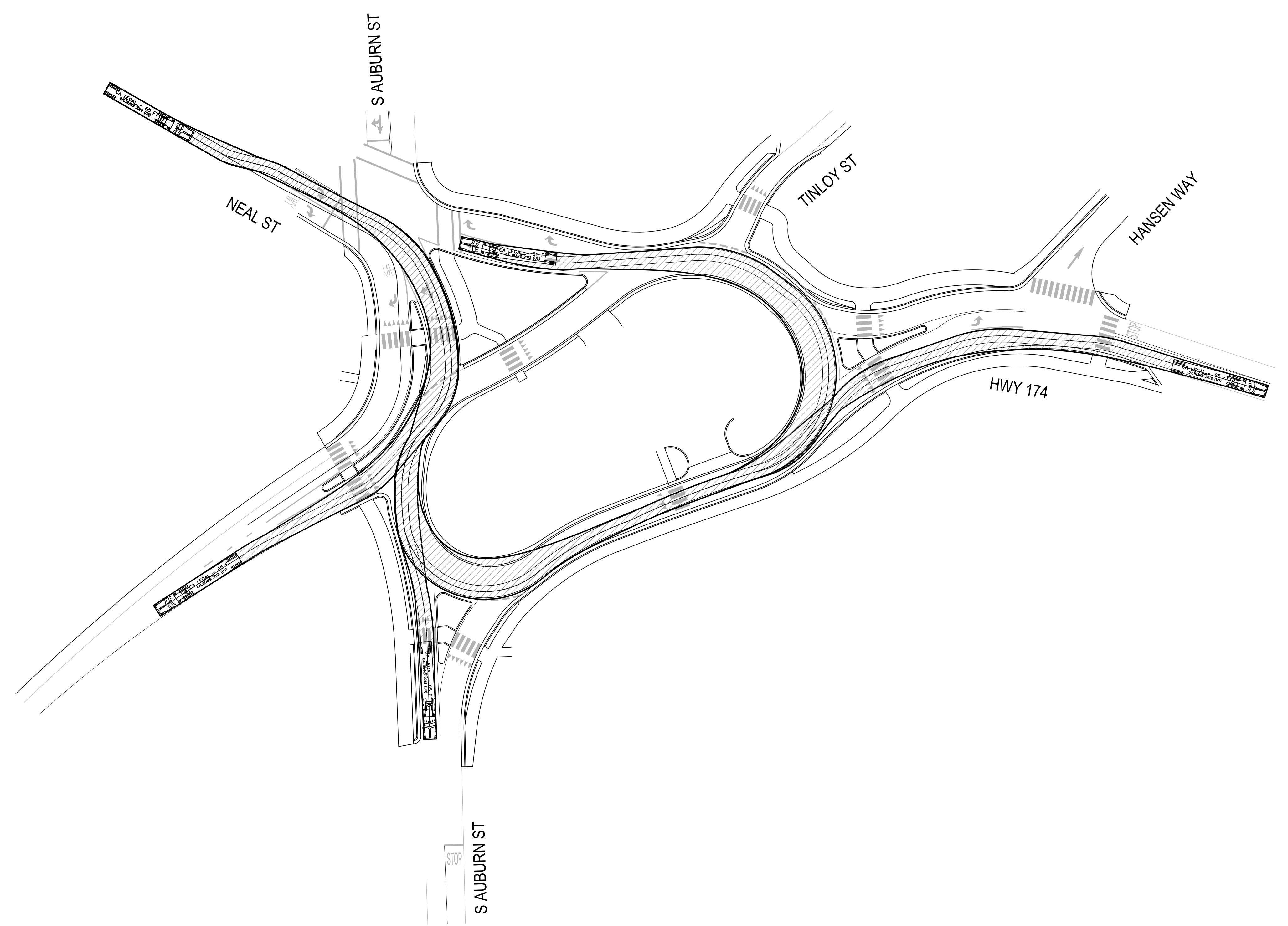
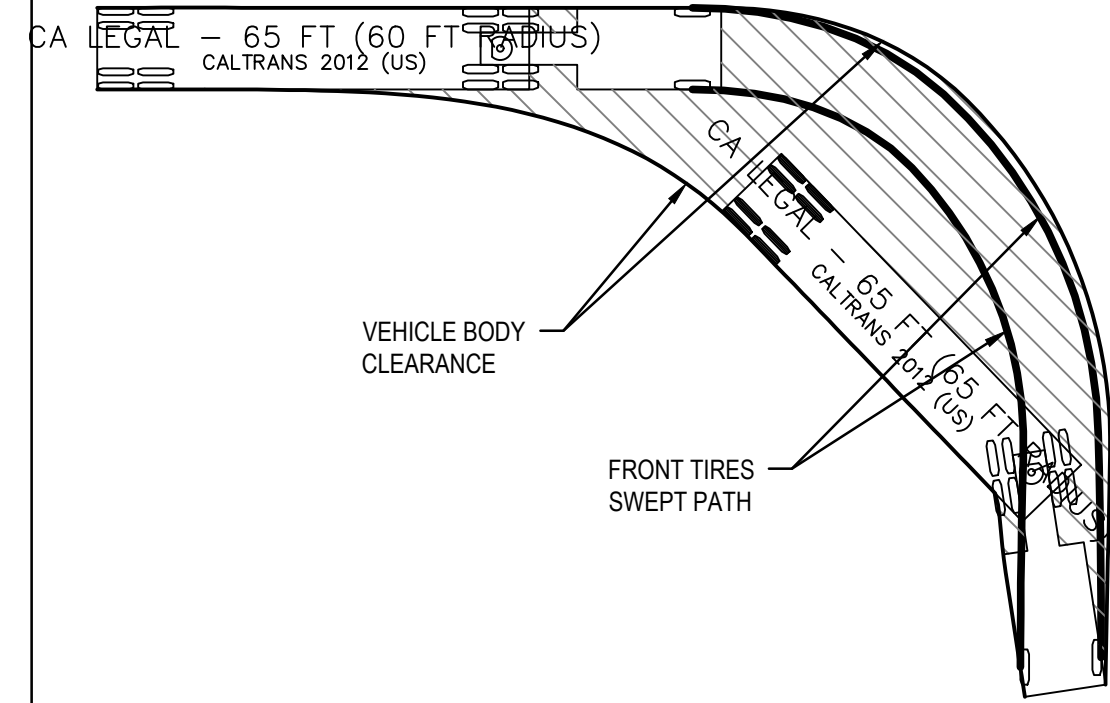

PRELIMINARY
SUBJECT TO CHANGE

GRASS VALLEY ROUNDABOUTS PROJECT
TRUCK TURNS - SOUTHBOUND NEAL ST



943 Reserve Drive, Suite 100
Roseville, CA 95678 USA
T 1 916 782 8688 W www.ghd.com

Project No. 2162
Date DEC 2019

FIGURE 07

Filename: N:\US\Roseville\Projects\Legacy\PRJ2612\2612EX004.dwg
Plot Date: 8 April 2020 - 1:47 PM

VEHICLE PROFILE

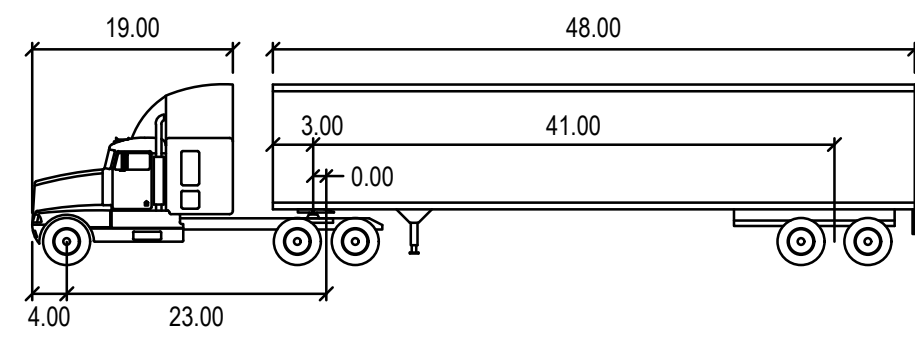

STAA - STANDARD	feet		
Tractor Width	: 8.50	Lock to Lock Time	: 6.0
Trailer Width	: 8.50	Steering Angle	: 26.3
Tractor Track	: 8.50	Articulating Angle	: 70.0
Trailer Track	: 8.50		

LEGEND

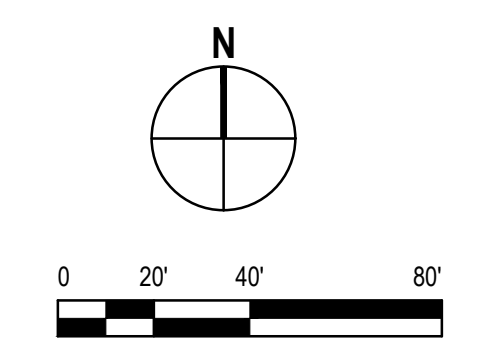
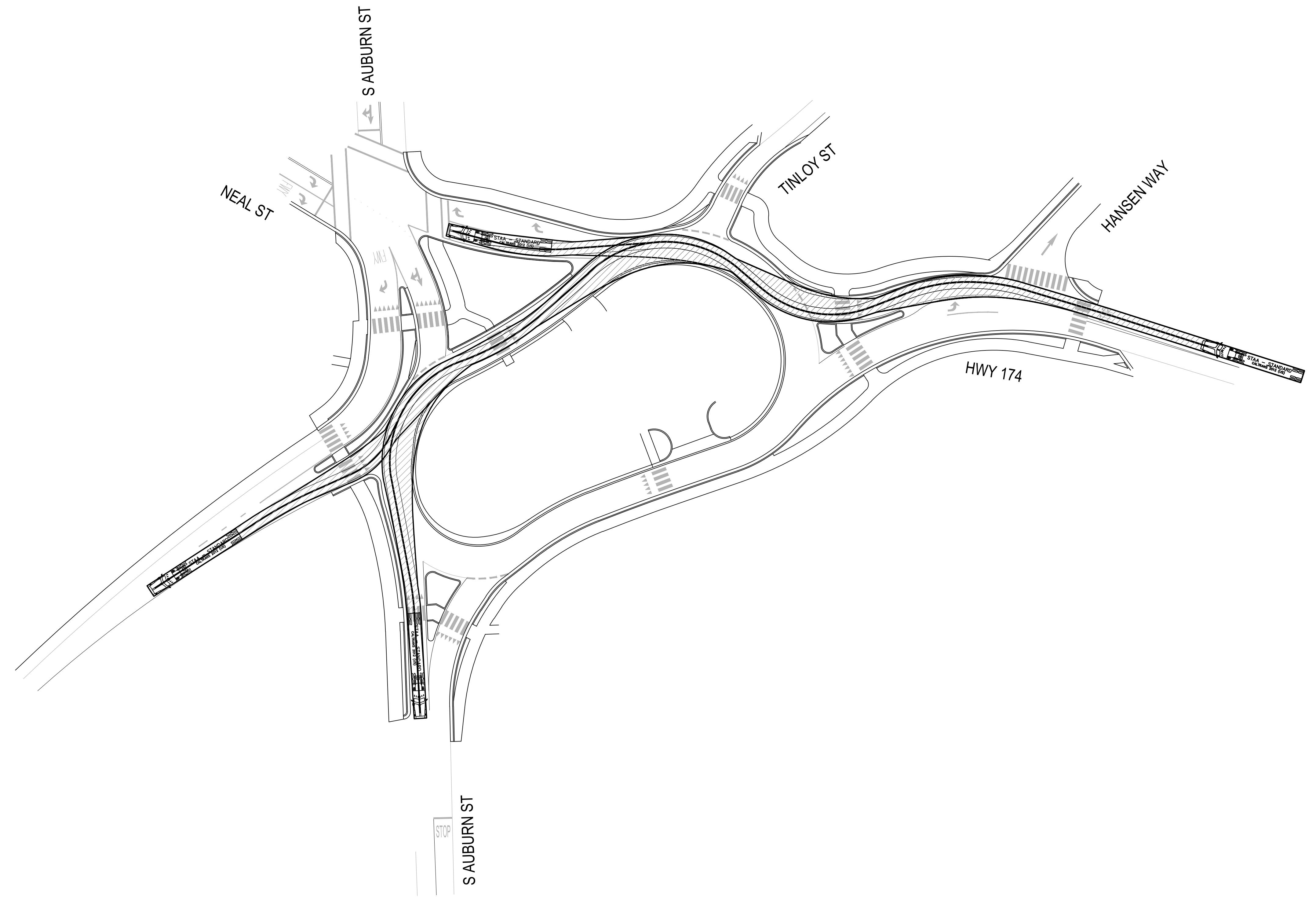
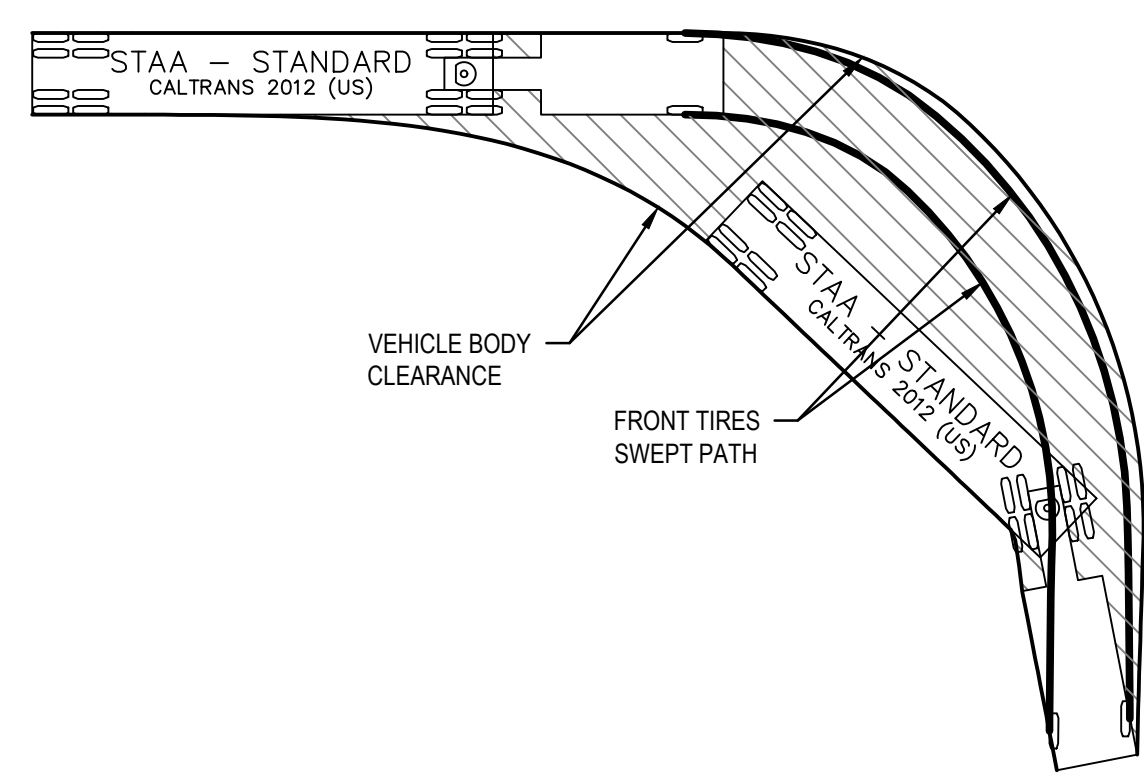

PRELIMINARY
SUBJECT TO CHANGE

GRASS VALLEY ROUNDABOUTS PROJECT
TRUCK TURNS - WESTBOUND HWY 174



Project No. 2162
Date DEC 2019

FIGURE 08

VEHICLE PROFILE

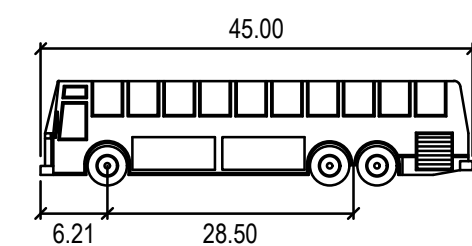

45' COACH BUS feet
 Width : 8.50
 Track : 8.50
 Lock to Lock Time : 6.0
 Steering Angle : 44.3

LEGEND

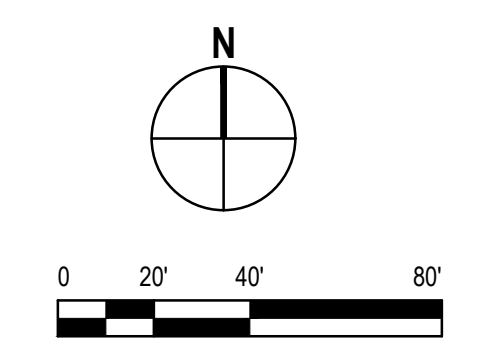
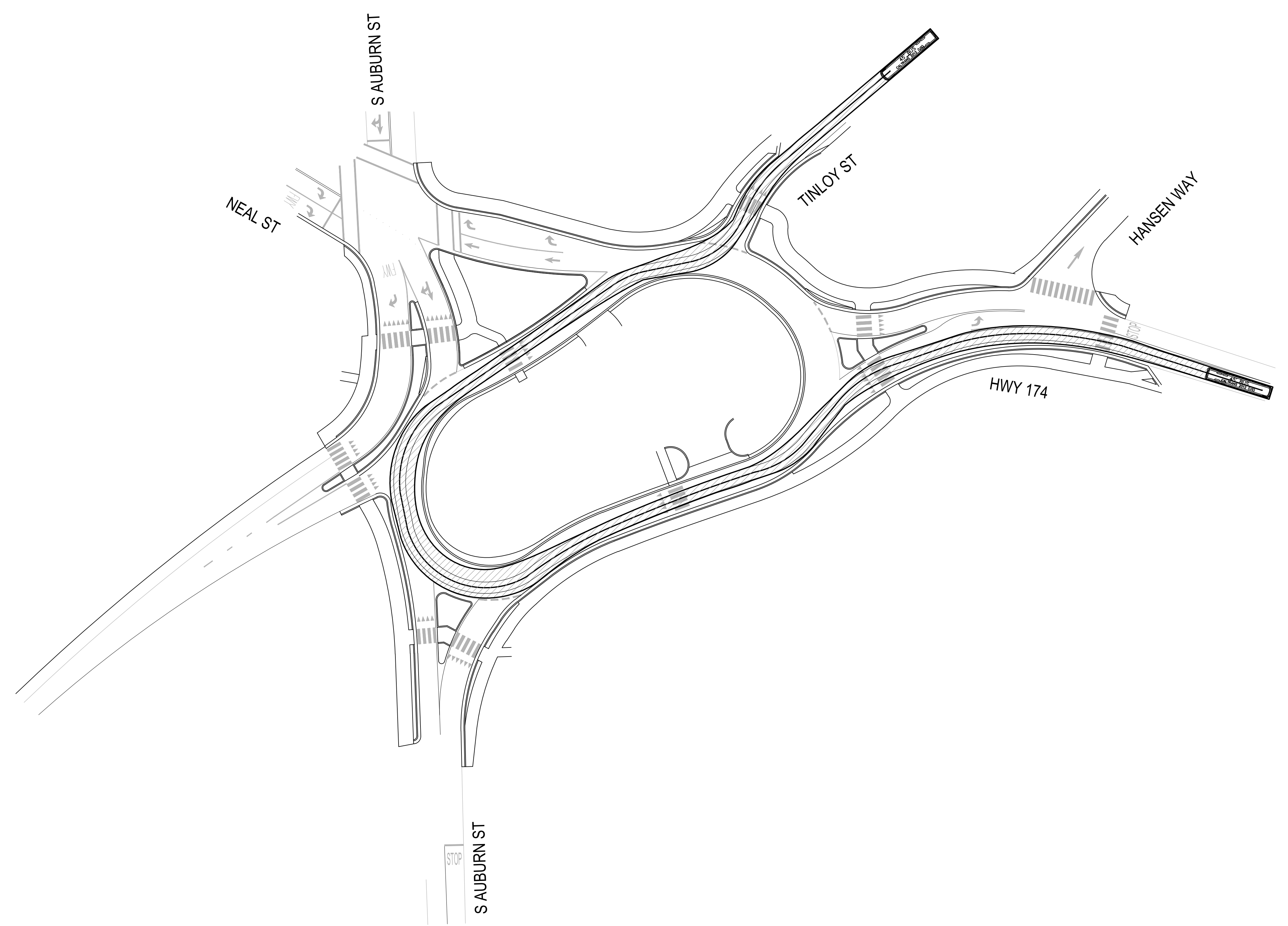
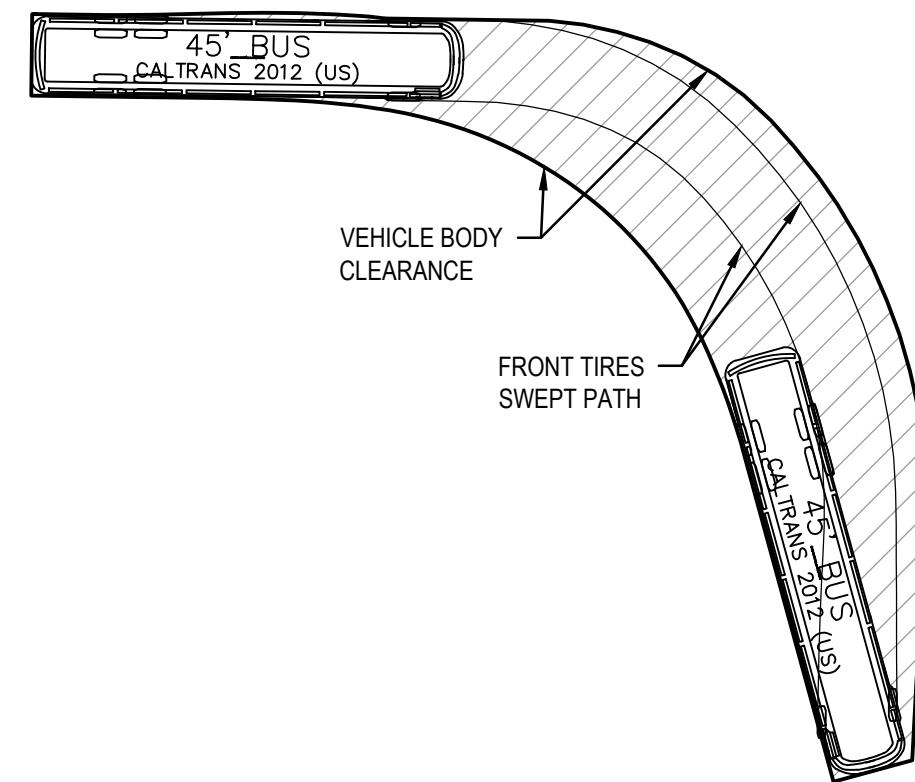

PRELIMINARY
 SUBJECT TO CHANGE

GRASS VALLEY ROUNDABOUTS PROJECT
 BUS TURNS - WESTBOUND TINLOY ST-CA LEGAL



Project No. 2162
 Date DEC 2019

FIGURE 17

Filename: N:\US\Roseville\Projects\Legacy\PRJ2612\2612EX004.dwg
 Plot Date: 8 April 2020 - 1:47 PM

VEHICLE PROFILE

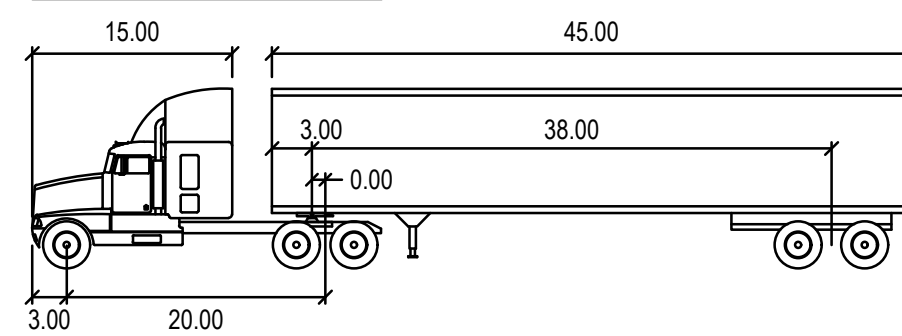

CA LEGAL - 65 FT (60 FT RADIUS)
feet

Tractor Width	: 8.50	Lock to Lock Time	: 6.0
Trailer Width	: 8.50	Steering Angle	: 26.3
Tractor Track	: 8.50	Articulating Angle	: 70.0
Trailer Track	: 8.50		

LEGEND

CA LEGAL - 65 FT (60 FT RADIUS)
CALTRANS 2012 (US)

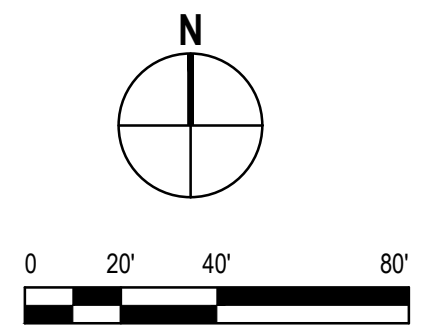
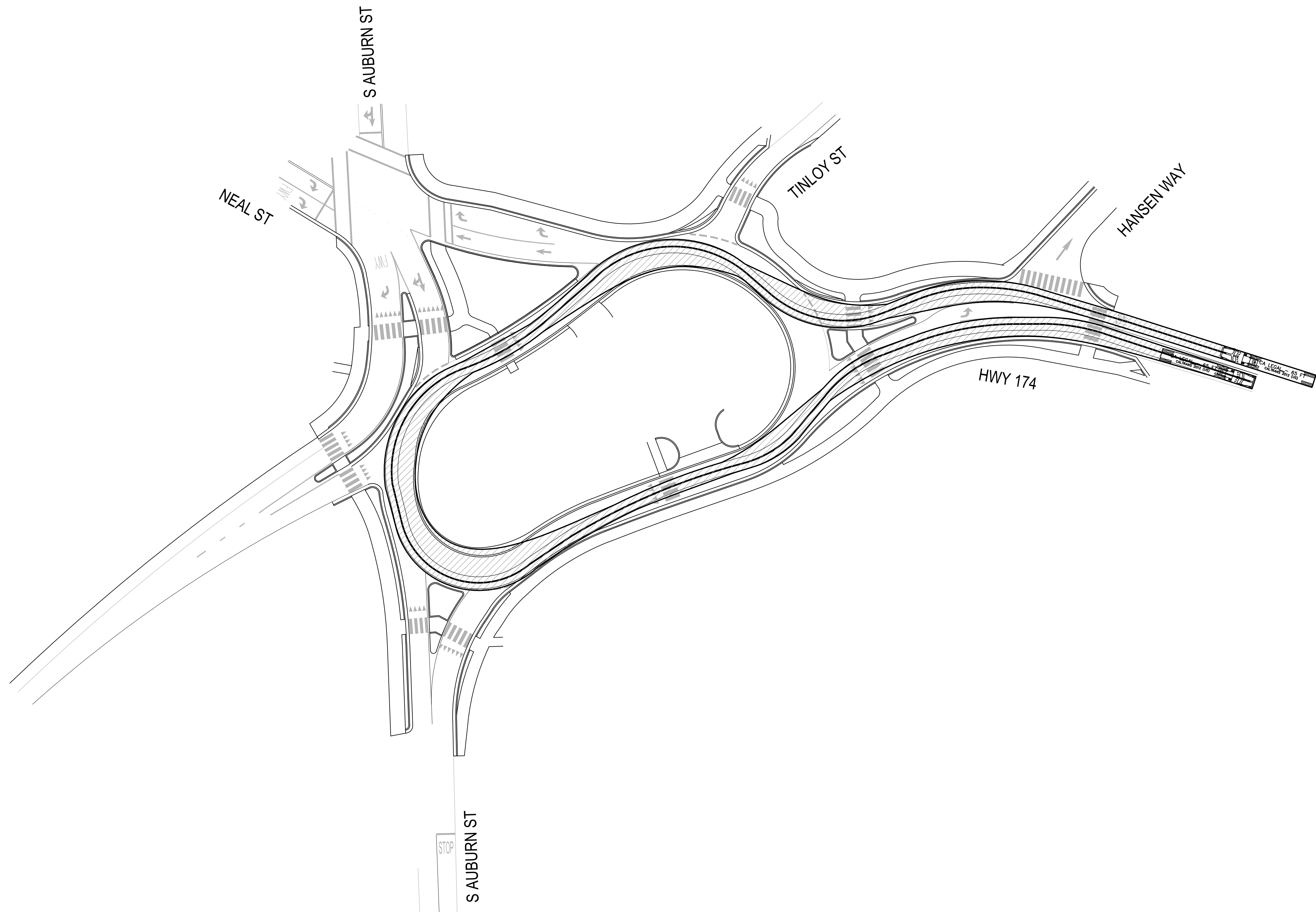
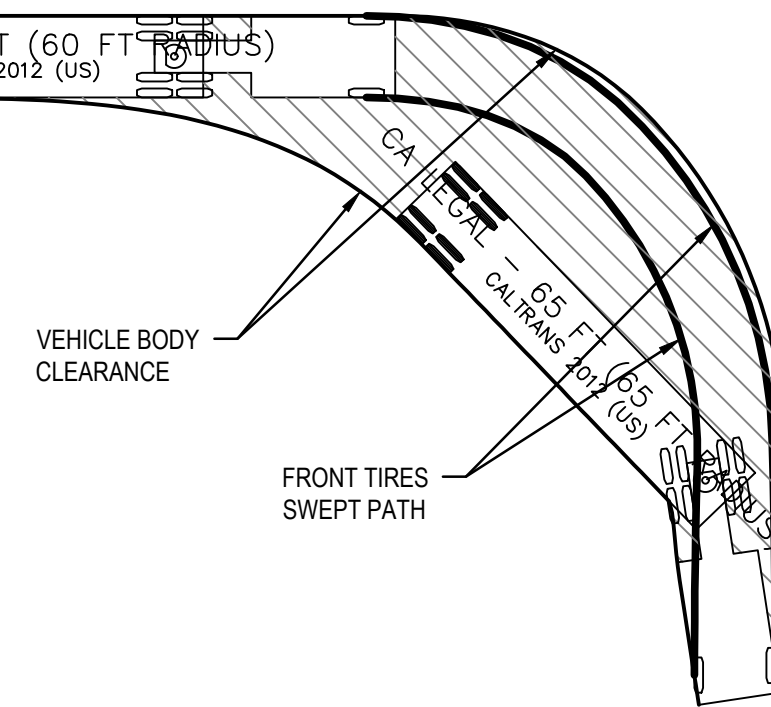

PRELIMINARY
SUBJECT TO CHANGE

GRASS VALLEY ROUNDABOUTS PROJECT
BUS TURNS - WESTBOUND HWY 174-CA LEGAL



943 Reserve Drive, Suite 100
Roseville, CA 95678 USA
T 1 916 782 8688 W www.ghd.com

Project No. 2162
Date DEC 2019

FIGURE 09

VEHICLE PROFILE

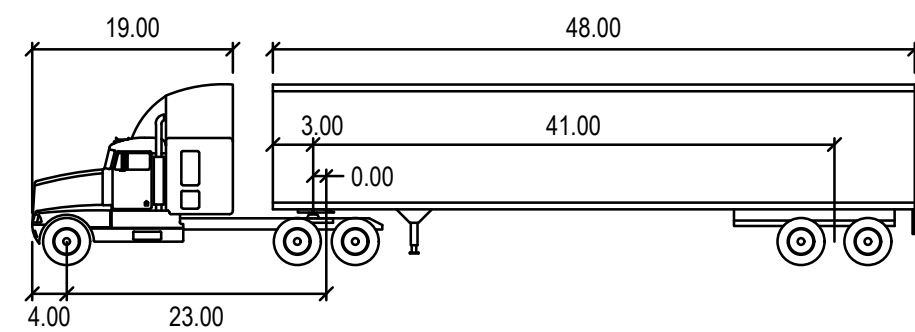

STAA - STANDARD	feet		
Tractor Width	: 8.50	Lock to Lock Time	: 6.0
Trailer Width	: 8.50	Steering Angle	: 26.3
Tractor Track	: 8.50	Articulating Angle	: 70.0
Trailer Track	: 8.50		

LEGEND

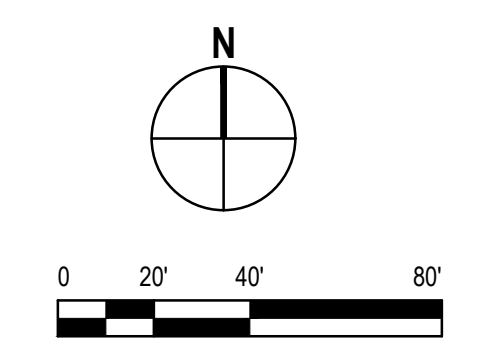
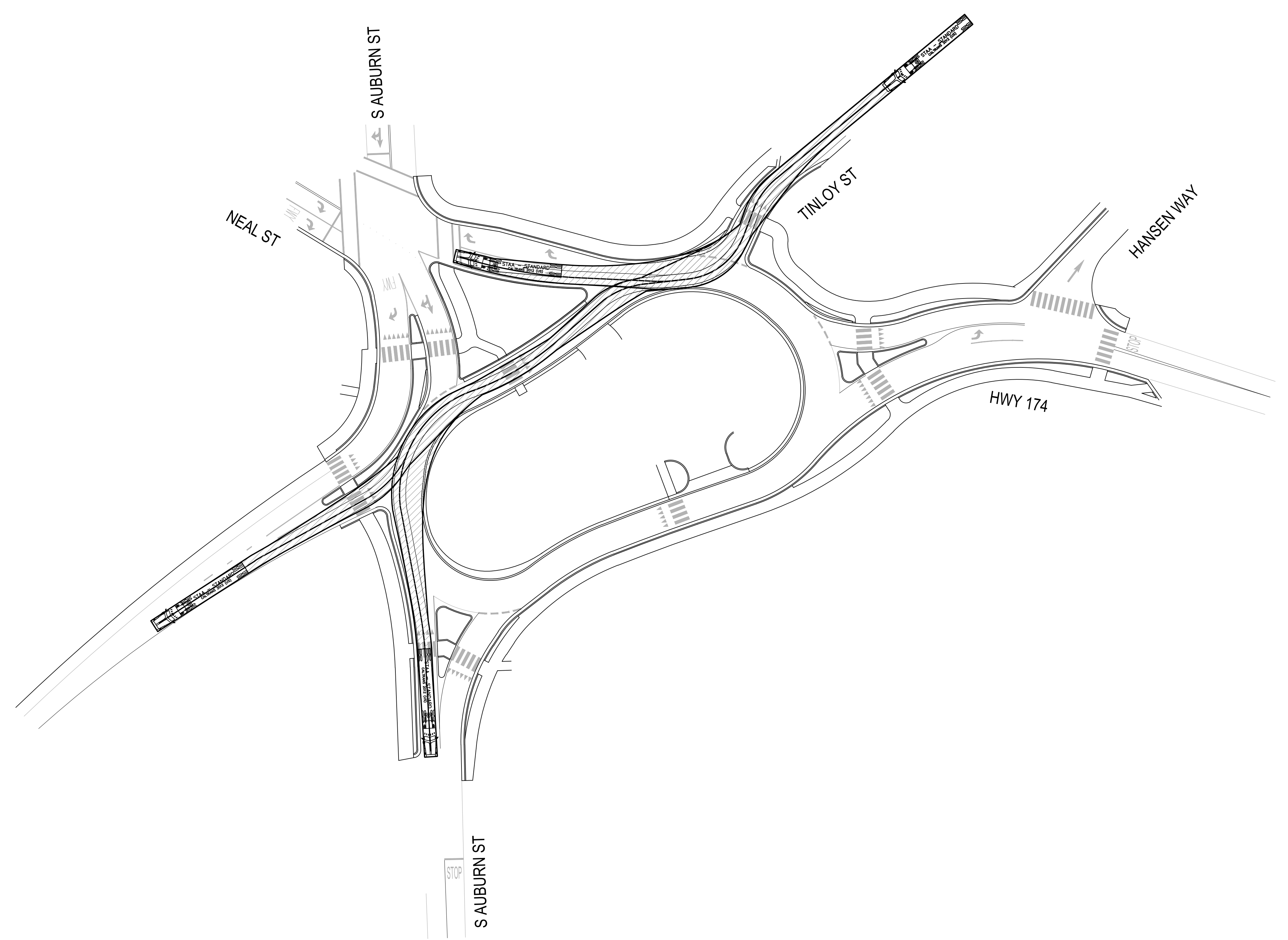
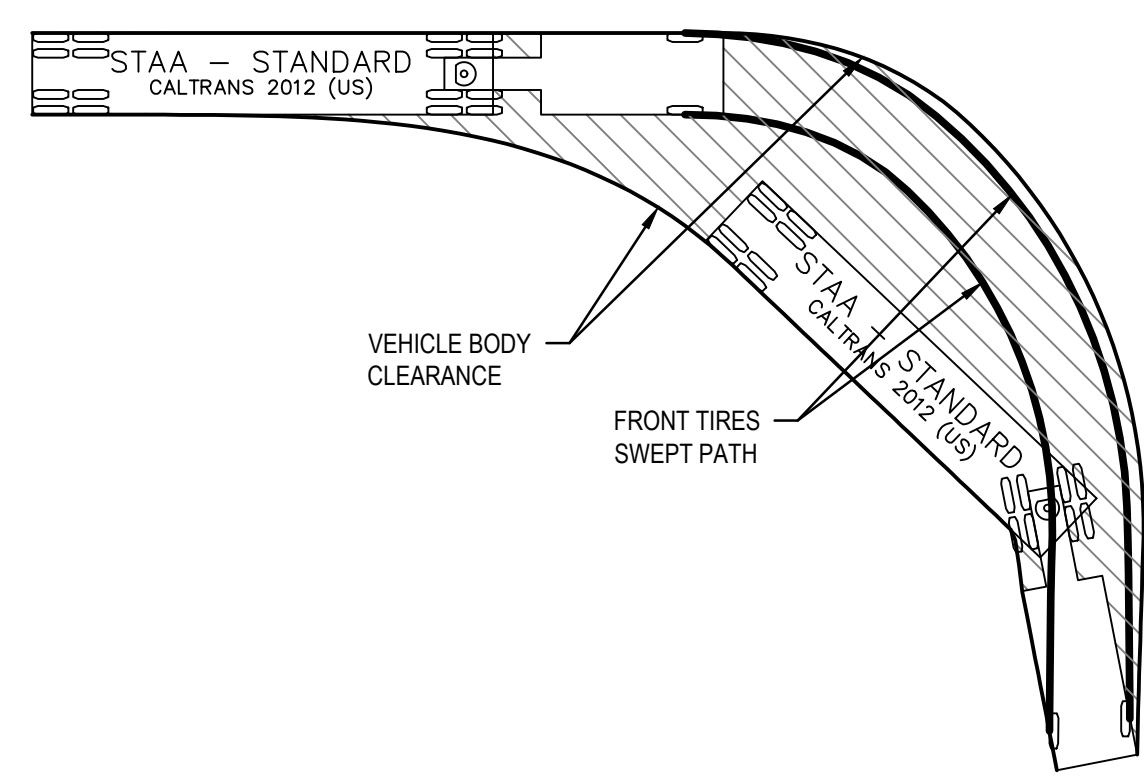

PRELIMINARY
SUBJECT TO CHANGE

GRASS VALLEY ROUNDABOUTS PROJECT
TRUCK TURNS - WESTBOUND TINLOY ST



943 Reserve Drive, Suite 100
Roseville, CA 95678 USA
T 1 916 782 8688 W www.ghd.com

Project No. 2162
Date DEC 2019

FIGURE 10

Filename: N:\US\Roseville\Projects\Legacy\PRJ2612\2612EX004.dwg
Plot Date: 8 April 2020 - 1:47 PM

VEHICLE PROFILE

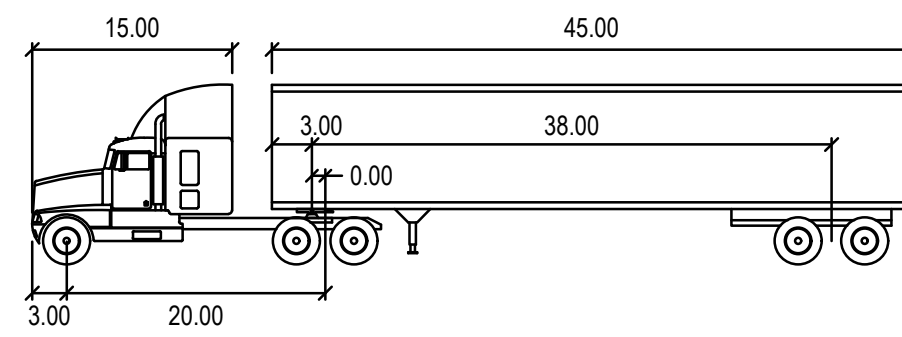

CA LEGAL - 65 FT (60 FT RADIUS)
feet

Tractor Width	: 8.50	Lock to Lock Time	: 6.0
Trailer Width	: 8.50	Steering Angle	: 26.3
Tractor Track	: 8.50	Articulating Angle	: 70.0
Trailer Track	: 8.50		

LEGEND

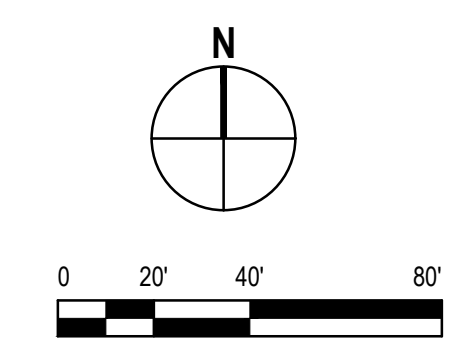
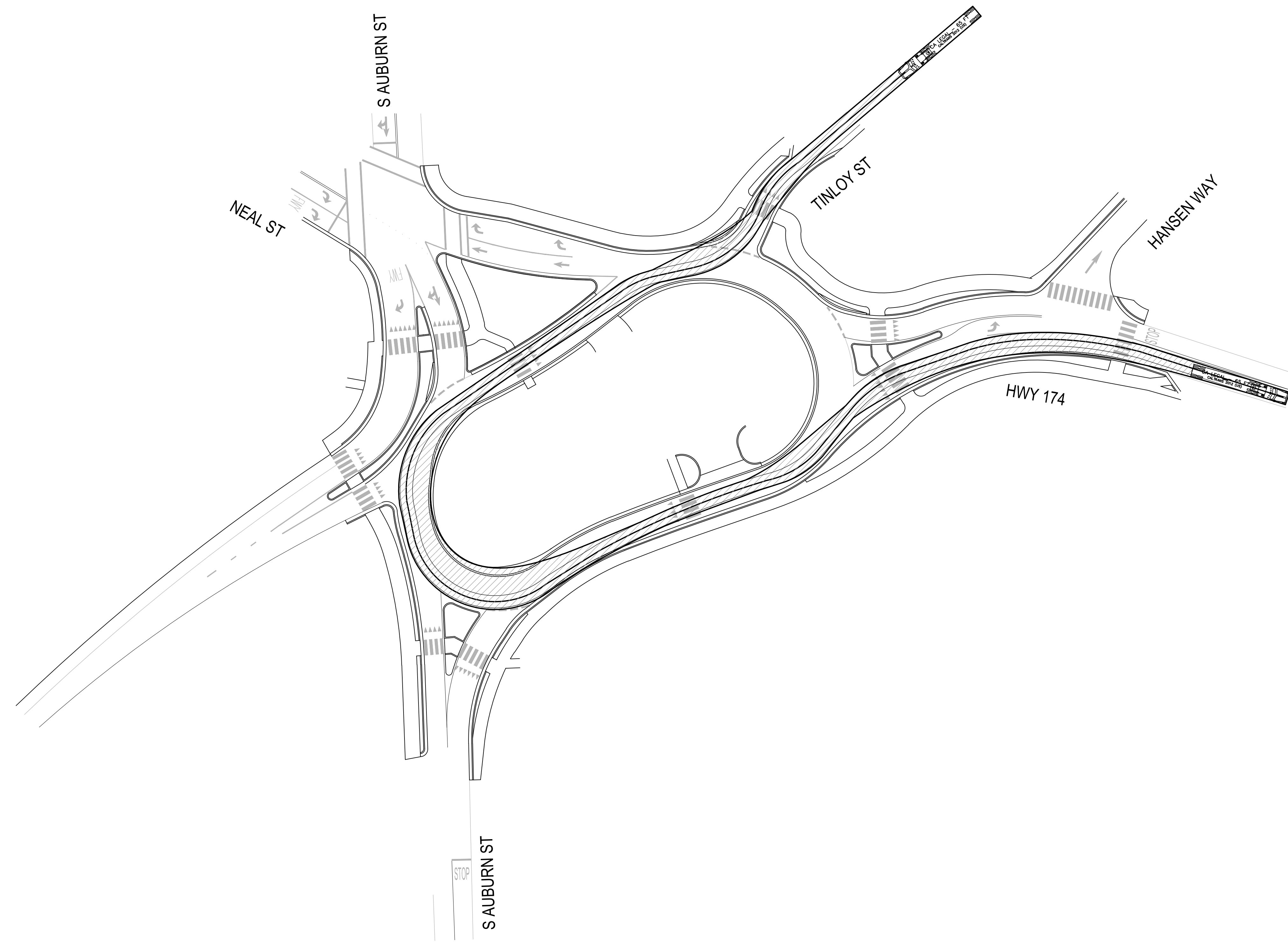
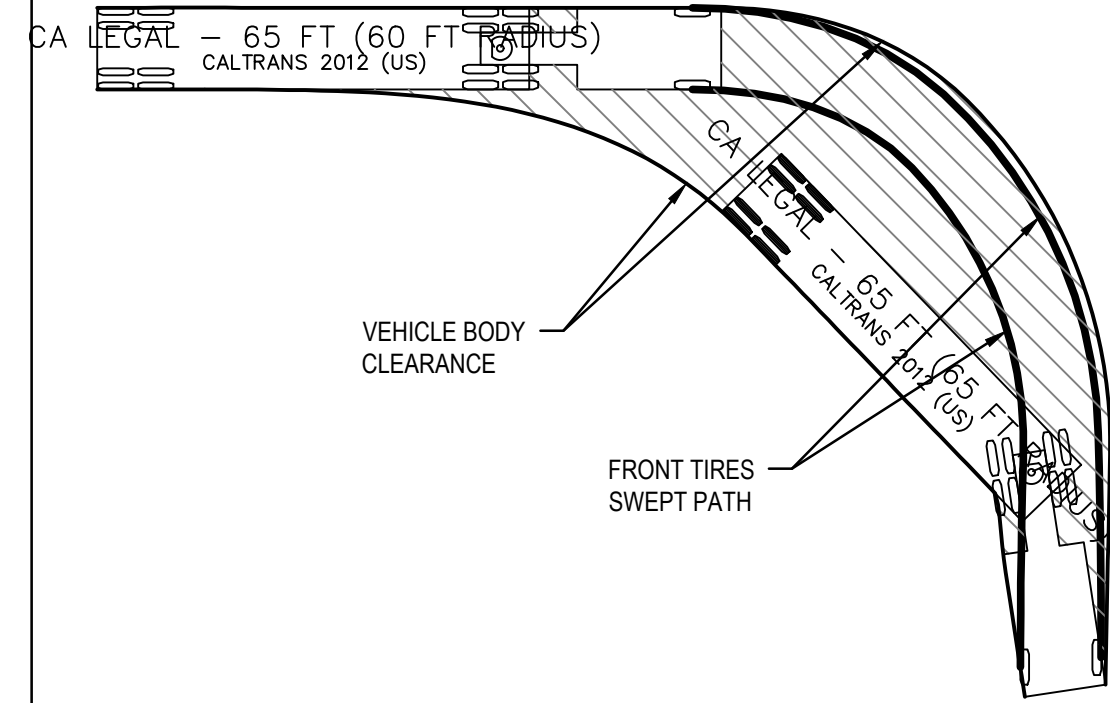

PRELIMINARY
SUBJECT TO CHANGE

GRASS VALLEY ROUNDABOUTS PROJECT
TRUCK TURNS - WESTBOUND TINLOY ST-CA LEGAL



943 Reserve Drive, Suite 100
Roseville, CA 95678 USA
T 916 782 8688 W www.ghd.com

Project No. 2162
Date DEC 2019

FIGURE 11

Filename: N:\US\Roseville\Projects\Legacy\PRJ2612\2612EX004.dwg
Plot Date: 8 April 2020 - 1:47 PM

VEHICLE PROFILE

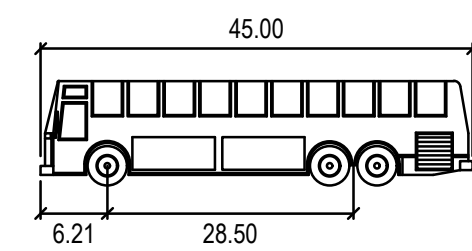

45' COACH BUS feet
 Width : 8.50
 Track : 8.50
 Lock to Lock Time : 6.0
 Steering Angle : 44.3

LEGEND

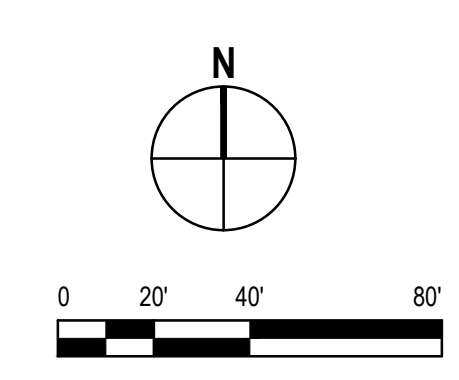
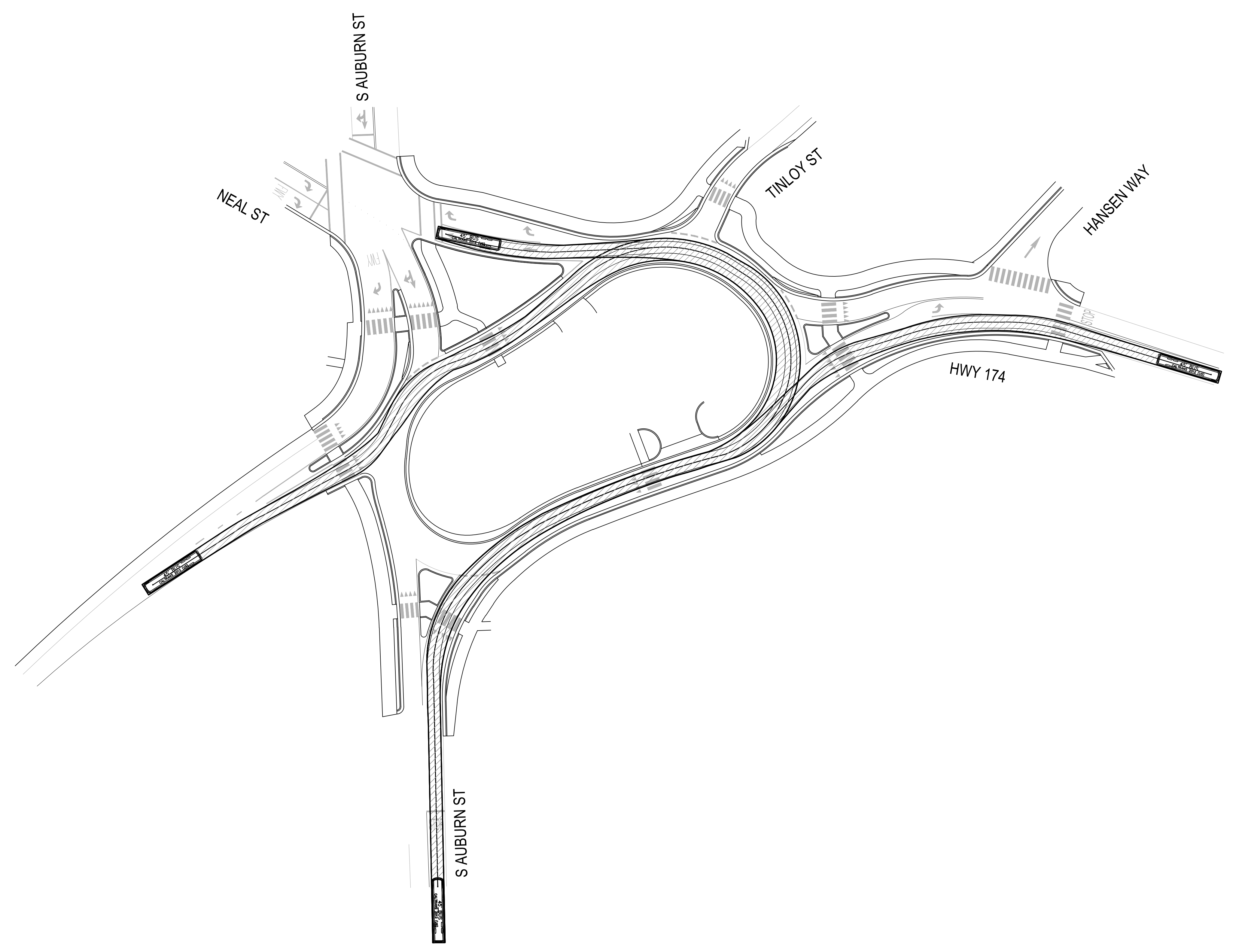
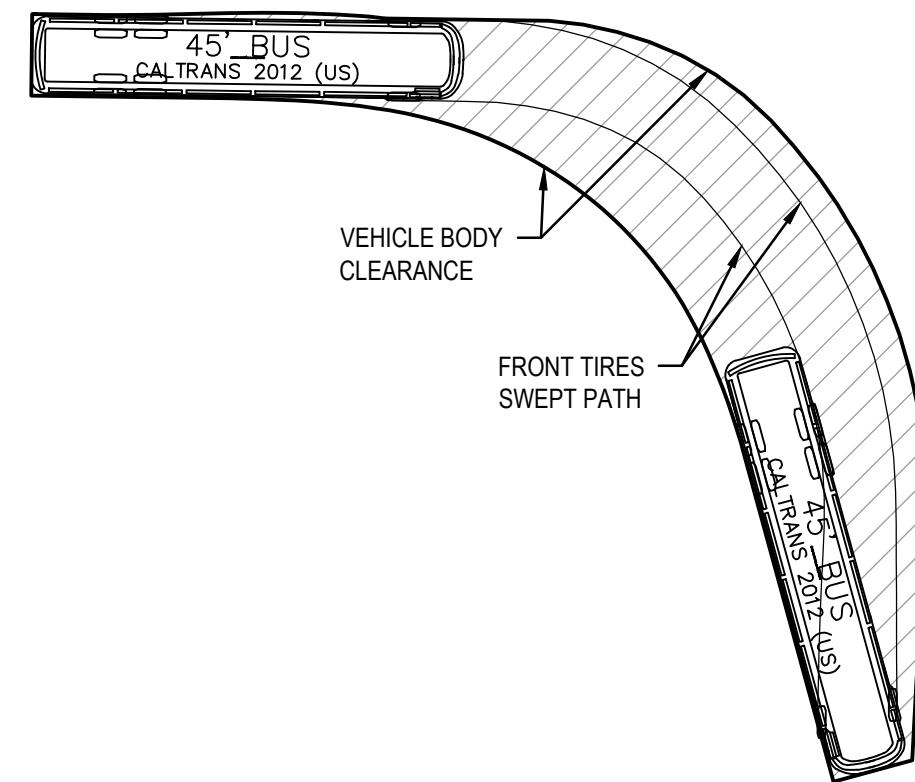

PRELIMINARY
 SUBJECT TO CHANGE

GRASS VALLEY ROUNDABOUTS PROJECT
 BUS TURNS - NORTHBOUND S AUBURN ST



Project No. 2162
 Date DEC 2019

FIGURE 12

Filename: N:\US\Roseville\Projects\Legacy\PRJ2612\2612EX004.dwg
 Plot Date: 8 April 2020 - 1:47 PM

VEHICLE PROFILE

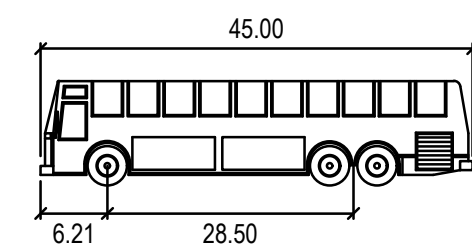

45' COACH BUS feet
 Width : 8.50
 Track : 8.50
 Lock to Lock Time : 6.0
 Steering Angle : 44.3

LEGEND

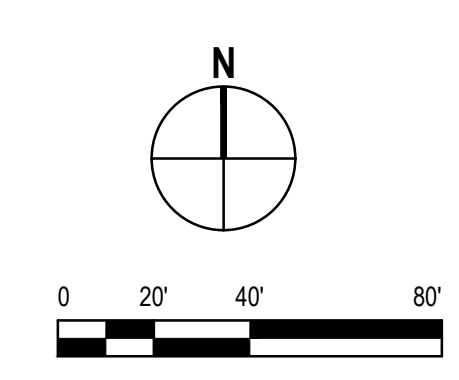
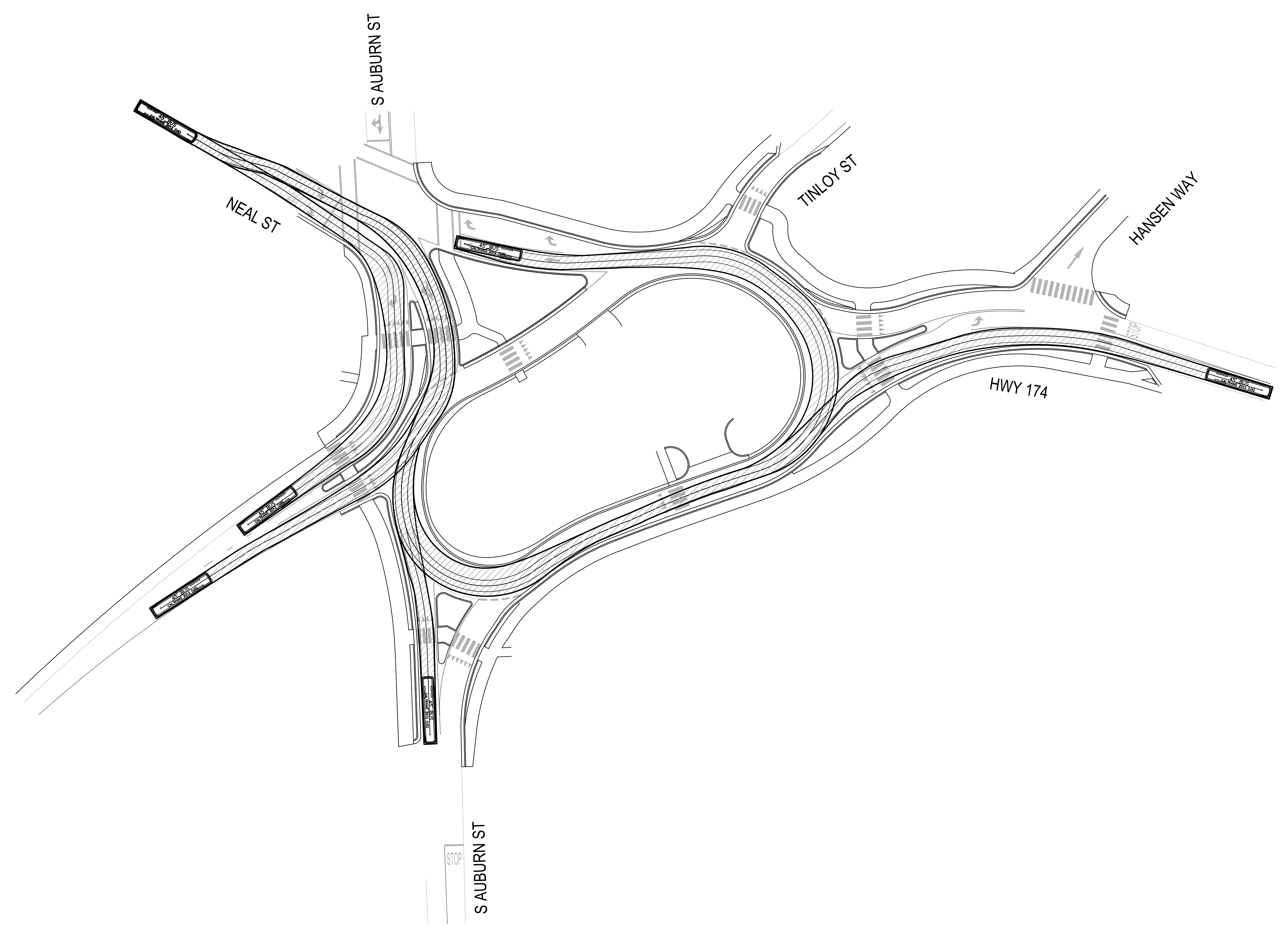
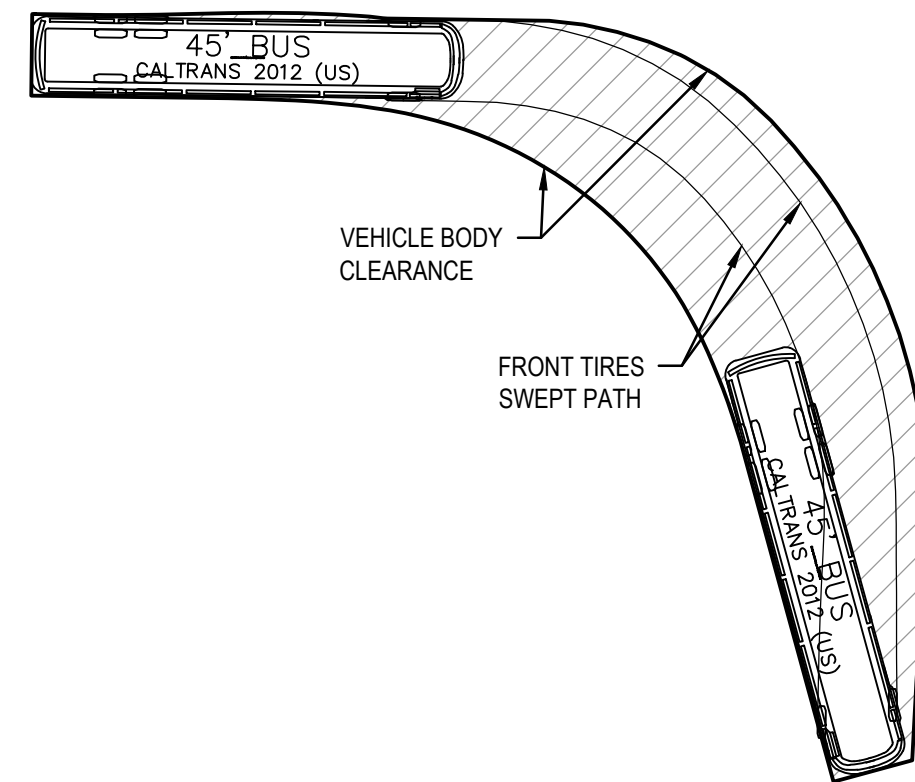

PRELIMINARY
 SUBJECT TO CHANGE

GRASS VALLEY ROUNDABOUTS PROJECT
 BUS TURNS - SOUTHBOUND NEAL ST



Project No. 2162
 Date DEC 2019

FIGURE 13

Filename: N:\US\Roseville\Projects\Legacy\PRJ2612\2612EX004.dwg
 Plot Date: 8 April 2020 - 1:47 PM

VEHICLE PROFILE

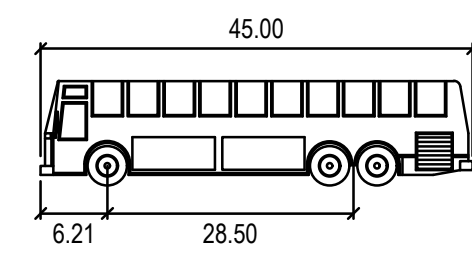

45' COACH BUS feet
 Width : 8.50
 Track : 8.50
 Lock to Lock Time : 6.0
 Steering Angle : 44.3

LEGEND

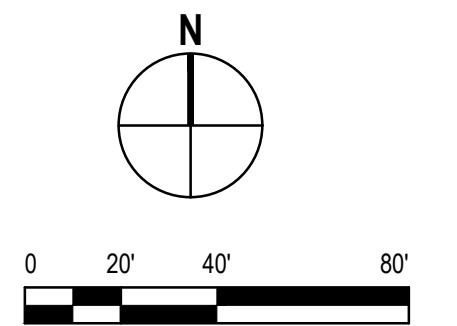
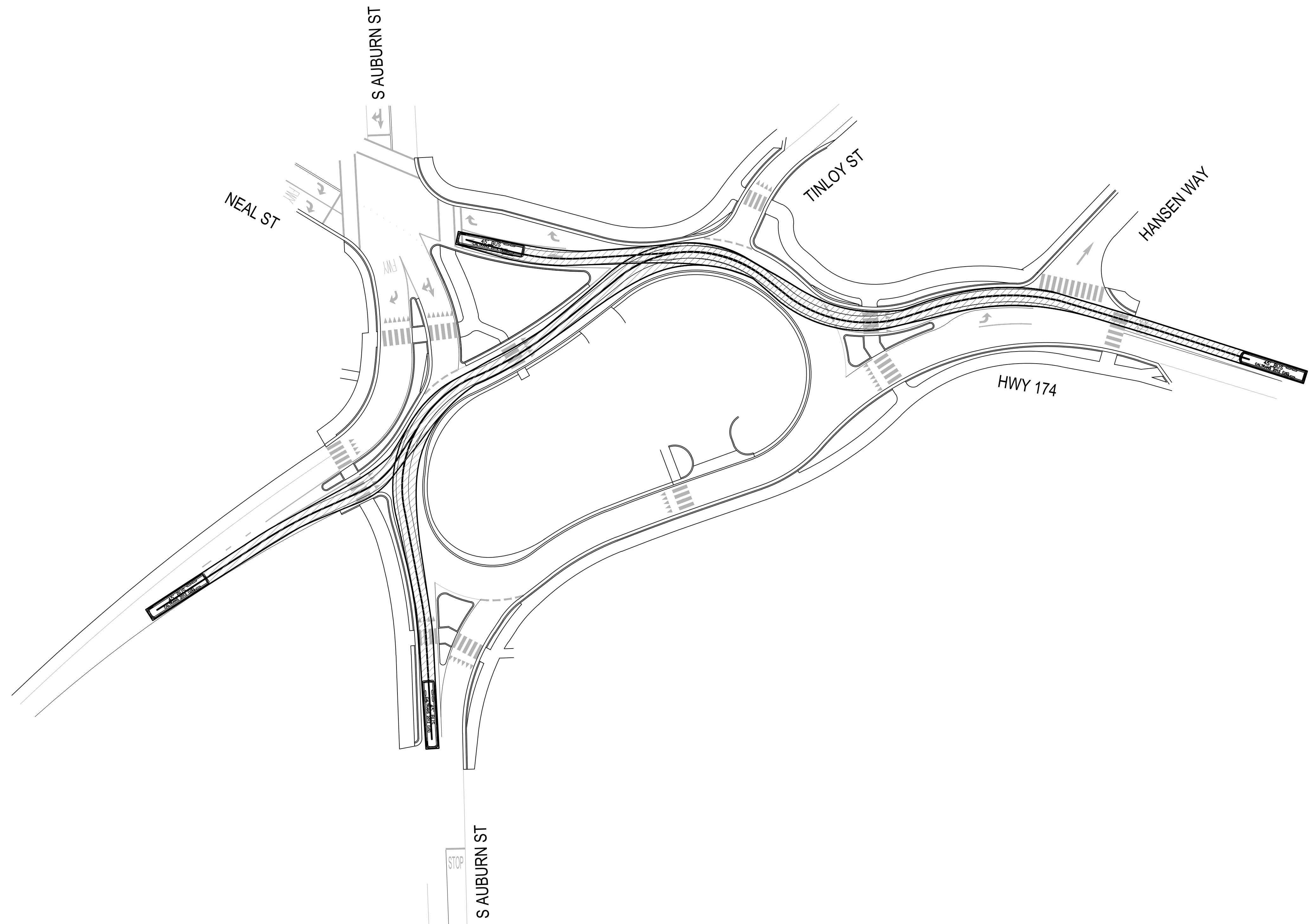
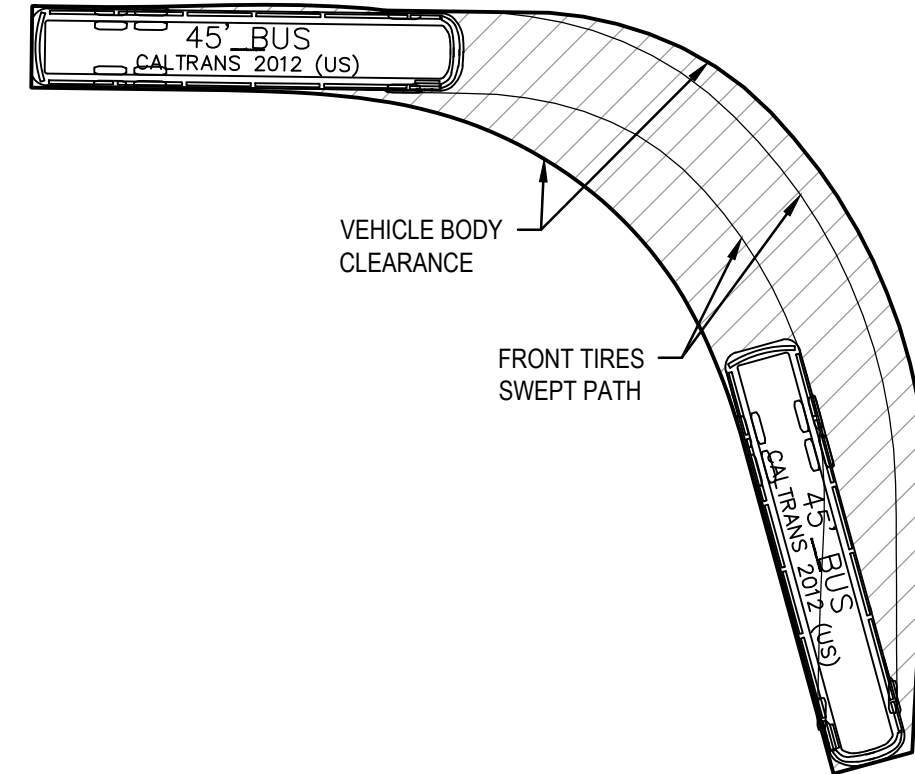

PRELIMINARY
 SUBJECT TO CHANGE

GRASS VALLEY ROUNDABOUTS PROJECT
 BUS TURNS - WESTBOUND HWY 174



943 Reserve Drive, Suite 100
 Roseville, CA 95678 USA
 T 916 782 8688 W www.ghd.com

Project No. 2162
 Date DEC 2019

FIGURE 14

VEHICLE PROFILE

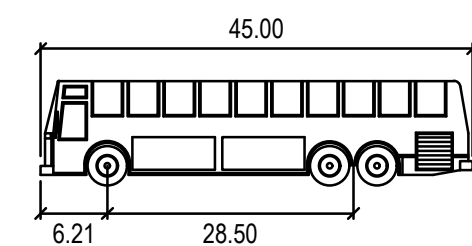

45' COACH BUS feet
 Width : 8.50
 Track : 8.50
 Lock to Lock Time : 6.0
 Steering Angle : 44.3

LEGEND

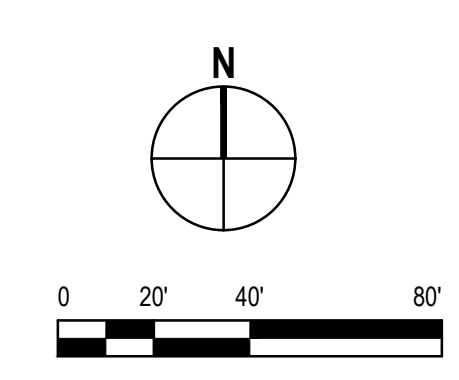
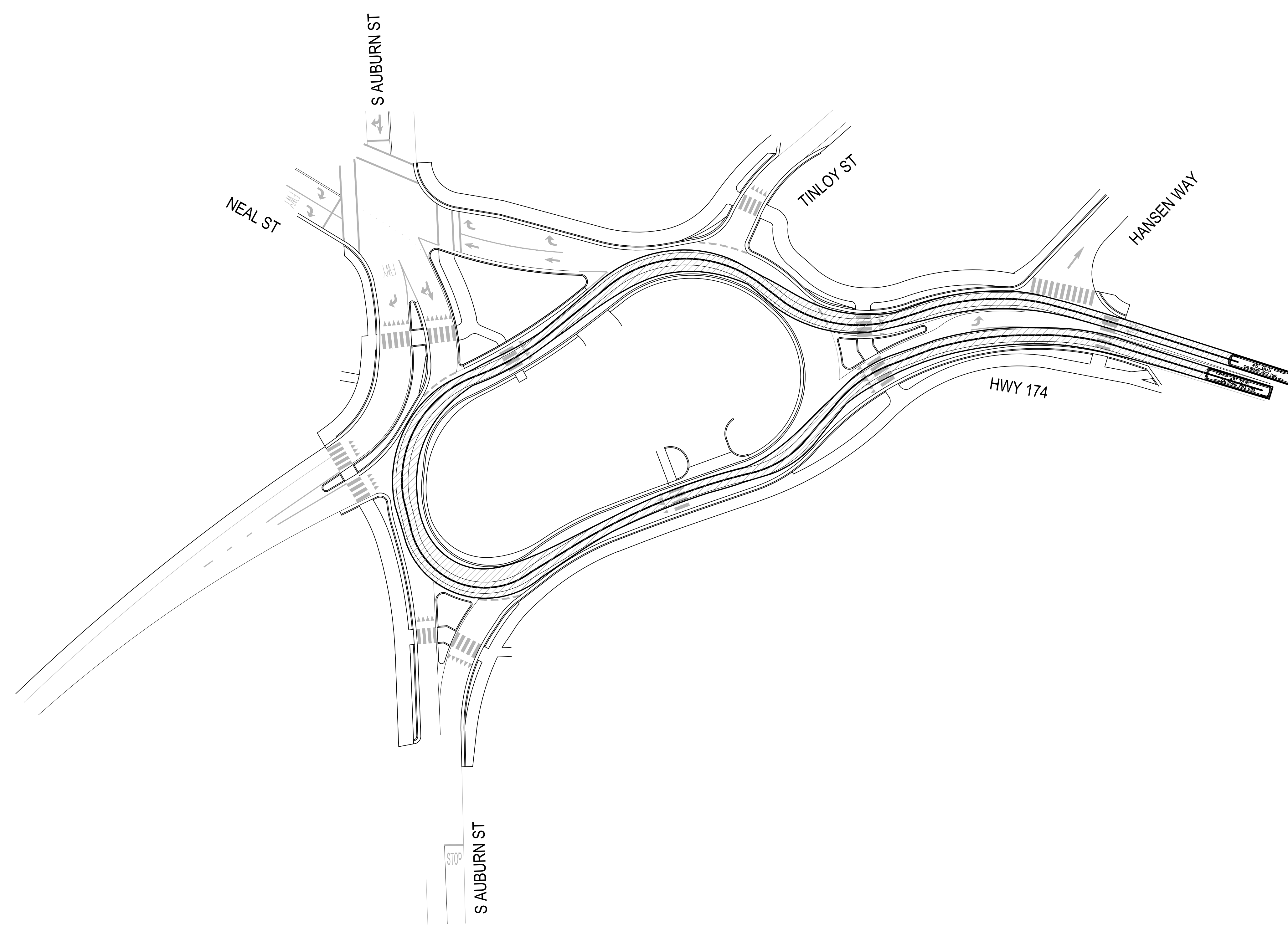
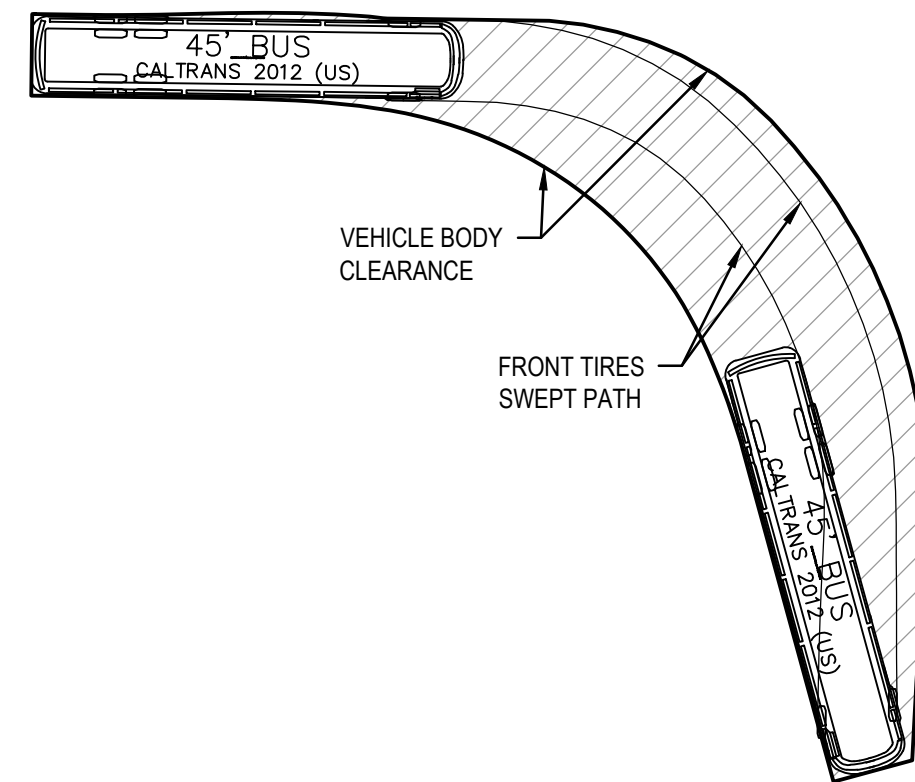

PRELIMINARY
 SUBJECT TO CHANGE

GRASS VALLEY ROUNDABOUTS PROJECT

BUS TURNS - WESTBOUND HWY 174-CA LEGAL



Project No. 2162
 Date DEC 2019

FIGURE 15

Filename: N:\US\Roseville\Projects\Legacy\PRJ2612\2612EX004.dwg
 Plot Date: 8 April 2020 - 1:47 PM

VEHICLE PROFILE

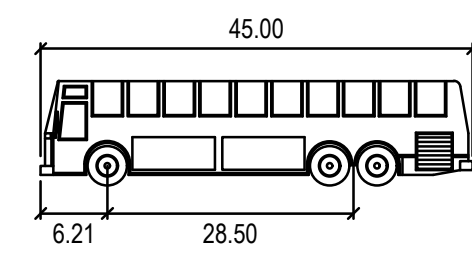

45' COACH BUS feet
 Width : 8.50
 Track : 8.50
 Lock to Lock Time : 6.0
 Steering Angle : 44.3

LEGEND

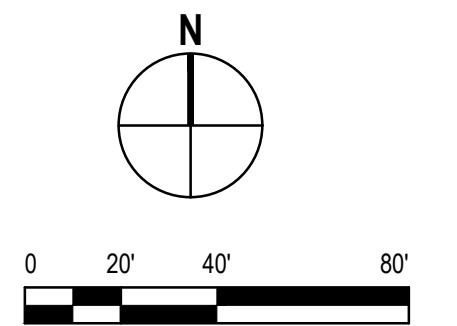
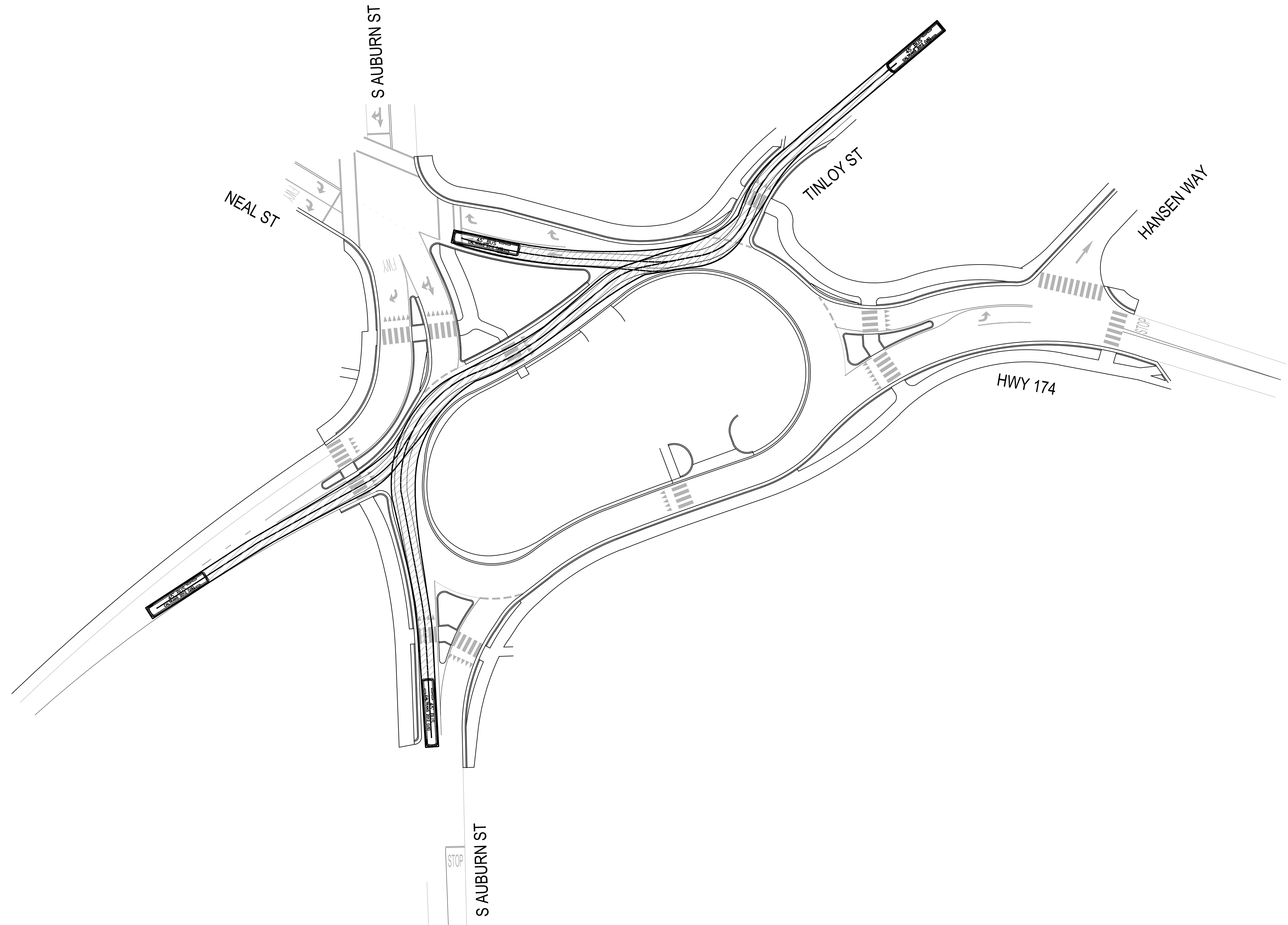
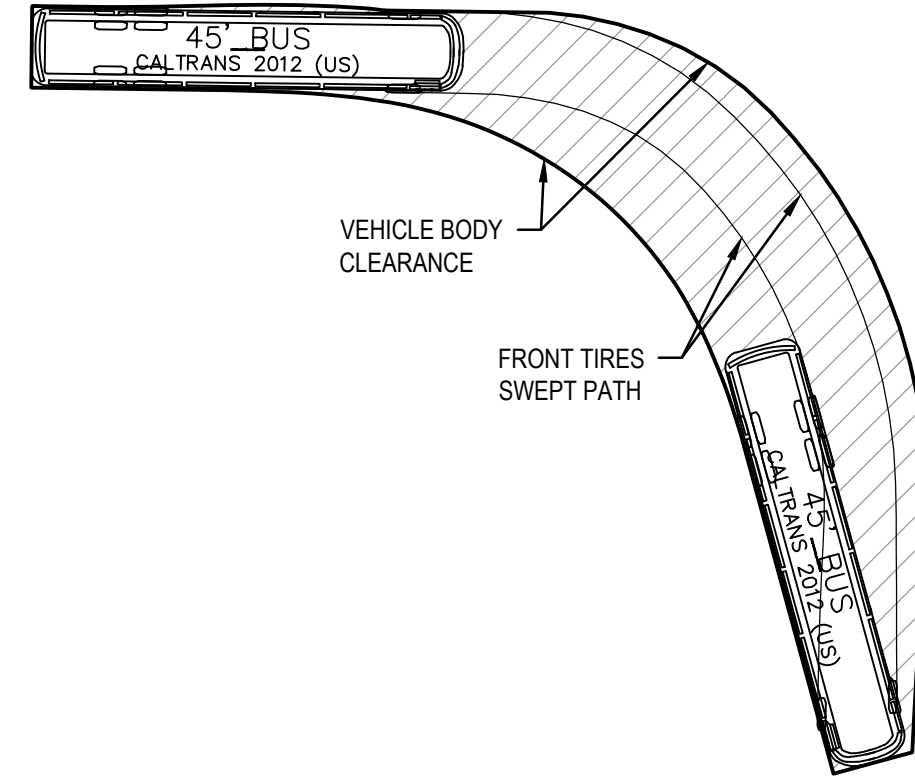

PRELIMINARY
 SUBJECT TO CHANGE

GRASS VALLEY ROUNDABOUTS PROJECT

BUS TURNS - WESTBOUND TINLOY ST



943 Reserve Drive, Suite 100
 Roseville, CA 95678 USA
 T 1 916 782 8688 W www.ghd.com

Project No. 2162
 Date DEC 2019

FIGURE 16